

Owner's Manual  
for Vehicle



**320i**  
**325i**  
**325xi**  
**330i**  
**330xi**

Congratulations, and thank you for choosing a BMW.

Thorough familiarity with your vehicle will provide you with enhanced control and security when you drive it. Therefore we have one request:

Please take the time to read this Owner's Manual and familiarize yourself with the information that we have compiled for you before starting off in your new BMW. The manual contains important data and instructions intended to assist you in obtaining maximum satisfaction from your BMW's unique array of advanced technical features. It also contains information on vehicle maintenance designed to enhance operating safety while simultaneously helping you to maintain your BMW's value throughout an extended service life. For additional information refer to the supplemental manuals.

This Owner's Manual should be considered a permanent part of this vehicle. It should stay with the vehicle when sold to provide the next owner with important operating, safety and maintenance information.

We wish you an enjoyable driving experience.

BMW AG

## 4 Notes

### About this Owner's Manual

We have made every effort to ensure that you are able to find what you need in this Owner's Manual as quickly as possible. The fastest way to find specific topics is by using the detailed index at the end. If you wish to gain an initial overview of your vehicle, you will find this in the first chapter.

Should you wish to sell your BMW at some time in the future, please remember to hand over this Owner's Manual to the new owner; it is an important part of the vehicle.

### Additional sources of information

If you have any additional questions, your BMW center will be glad to advise you.

You can find more information about BMW, for example on its technology, on the Internet at [www.bmw.com](http://www.bmw.com).

### Symbols used



Indicates precautions that must be followed precisely in order to avoid the possibility of personal injury and serious damage to the vehicle.



Contains information that will assist you in gaining the optimum benefit from your vehicle and enable you to care more effectively for your vehicle.



Refers to measures that can be taken to help protect the environment.

◀ Marks the end of a specific item of information.

\* Indicates special equipment, country-specific equipment and optional extras when available.



Vehicle Memory, Key Memory, refer to page 64. Identifies functions that can be specifically adapted for a particular key or vehicle. These adjustments can be performed either by yourself or by your BMW center.

© 2003 Bayerische Motoren Werke  
Aktiengesellschaft  
Munich, Germany

Reprinting, including excerpts, only with the  
written consent of BMW AG, Munich.

Order No. 01 41 0 157 602

US English VIII/03

Printed in Germany

Printed on environmentally friendly paper,  
bleached without chlorine, suitable for recycling.

## Notes

### Your individual vehicle

On purchasing your BMW, you have decided in favor of a model with individualized equipment and features. This Owner's Manual describes all models and equipment that BMW offers within the same group.

We hope you will understand that equipment and features are included that you might not have chosen for your vehicle. You can easily identify any differences with the aid of the asterisk \* used to identify all optional equipment and accessories.

If your BMW features equipment which is not described in this Owner's Manual such as a car radio or telephone, Supplementary Owner's Manuals are enclosed. We ask you to read these manuals as well.

### Status at time of printing

BMW pursues a policy of continuous, ongoing development conceived to ensure that our vehicles continue to embody the highest quality and safety standards combined with advanced, state-of-the-art technology. For this reason, the features described in this Owner's Manual could differ from those on your vehicle. Nor can errors and omissions be entirely ruled out. You are therefore asked to appreciate that no claims can be recognized on the basis of the data, illustrations or descriptions in this Owner's Manual.

### For your own safety

#### Fuels



Use unleaded gasoline only. Fuels containing up to and including 10% ethanol or other oxygenates with up to 2.8% oxygen by weight – that is, 15% MTBE or 3% methanol plus an equivalent amount of co-solvent – will not void the applicable warranties respecting defects in materials or workmanship. Field experience has indicated significant differences in fuel quality – volatility, composition, additives, etc. among gasolines offered for sale in the United States and Canada. The use of poor-quality fuels may result in driveability, starting and stalling problems, especially under certain environmental conditions, such as high ambient temperature and high altitude. Should you encounter driveability problems which you suspect could be related to the fuel you are using, we recommend that you respond by switching to a recognized high-quality brand.

Failure to comply with these recommendations may result in unscheduled maintenance.

Obey all applicable safety rules when handling gasoline. ◀

### Maintenance and repair

 Advanced technology, e.g. the use of modern materials and high-performance electronics, requires specially adapted maintenance and repair methods. Therefore, only have corresponding work on your BMW carried out by a BMW center or a workshop that works according to BMW repair procedures with correspondingly trained personnel. If work is carried out improperly there is a danger of consequential damage and the related safety risks. ◀

### Parts and accessories

 Important safety information! For your own safety, use genuine parts and accessories approved by BMW.

When you purchase accessories tested and approved by BMW and Original BMW Parts, you simultaneously acquire the assurance that they have been thoroughly tested by BMW to ensure optimum performance when installed on your vehicle.

BMW warrants these parts to be free from defects in material and workmanship. BMW will not accept any liability for damage resulting from installation of parts and accessories not approved by BMW.

BMW cannot test every product on the market to determine whether it can be used on a BMW safely and without risk to either the vehicle, its operation, or its occupants.

Original BMW Parts, BMW Accessories and other products approved by BMW, together with professional advice on using these items, are available from all BMW centers.

Installation and operation of non-BMW approved accessories such as alarms, radios, amplifiers, radar detectors,

wheels, suspension components, brake dust shields, telephones – including operation of any portable cellular phone from within the vehicle without using an externally mounted antenna – or transceiver equipment such as a CB, walkie-talkie, ham radio or similar, may cause extensive damage to the vehicle, compromise its safety, interfere with the vehicle's electrical system or affect the validity of the BMW Limited Warranty. See your BMW center for additional information.

Do not use key or remote control to lock doors or luggage compartment with anyone inside the vehicle. Refer to the Owner's Manual for more details. ◀

 Maintenance, replacement, or repair of the emission control devices and systems may be performed by any automotive repair establishment or individual using any certified automotive part. ◀

### Symbol on vehicle parts

 Indicates that you should consult the relevant section of this Owner's Manual for information on a particular part or assembly.

## Notes

### Service and warranty

This manual is supplemented by a Service and Warranty Information Booklet for US models or a Warranty and Service Guide Booklet for Canadian models.

We recommend that you read this publication thoroughly.

Your BMW is covered by the following warranties:

- ▷ New Vehicle Limited Warranty
- ▷ Rust Perforation Limited Warranty
- ▷ Federal Emissions System Defect Warranty
- ▷ Federal Emissions Performance Warranty
- ▷ California Emission Control System Limited Warranty.

Detailed information about these warranties is listed in the Service and Warranty Information Booklet for US models or in the Warranty and Service Guide Booklet for Canadian models.

### Reporting safety defects

The following only applies to vehicles owned and operated in the US.

If you believe that your vehicle has a defect which could cause a crash or could cause injury or death, you should immediately inform the National Highway Traffic Safety Administration NHTSA in addition to notifying BMW of North America, LLC, P.O. Box 1227, Westwood, New Jersey 07675-1227, telephone toll-free 1-800-831-1117.

If NHTSA receives similar complaints, it may open an investigation, and if it finds that a safety defect exists in a group of vehicles, it may order a recall and remedy campaign. However, NHTSA cannot become involved in individual problems between you, your dealer, or BMW of North America, LLC.

To contact NHTSA, you may either call the Auto Safety Hotline toll-free at 1-800-424-9393 or 366-0123 in the Washington, D.C. area, or write to: NHTSA, U.S. Department of Transportation, Washington, D.C. 20590. You can also obtain other information about motor vehicle safety from the Hotline.

# Contents

<b>Notes</b>	About this Owner's Manual	4
	Additional sources of information	4
	Symbols used	4
	Your individual vehicle	5
	Status at time of printing	5
	For your own safety	5
	Symbol on vehicle parts	6
	Service and warranty	7
Reporting safety defects	7	

<b>Overview</b>	Cockpit	14
	Instrument cluster	16
	Indicator and warning lamps	18
	Buttons in steering wheel*	22
	Hazard warning triangle*	23
	First-aid kit*	23
	Refueling	24
	Fuel specifications	25
Tire inflation pressure	25	

<b>Controls and features</b>	<b>Opening and closing:</b>	
	Keys	32
	Central locking system	32
	Opening and closing – via the remote control	33
	Opening and closing – via the door lock	36
	Opening and closing – from the inside	37
	Luggage compartment lid	38
	Luggage compartment	40
	Alarm system*	41
	Electric power windows	43
	Glass sunroof, electric*	44
	<b>To adjust:</b>	
	Safe seating position	47
	Seats	48
Manual seat adjustment	48	
Power seat adjustment*	50	
Lumbar support*	50	
Head restraints	51	
Safety belts	51	
Seat and mirror memory*	53	
Seat heating*	54	
Steering wheel	55	
Mirrors	55	
<b>Passenger safety systems:</b>		
Airbags	57	
Transporting children safely	60	
Vehicle Memory, Key Memory	64	



# Contents

<b>Controls and features</b>	<b>Driving:</b>			
	Ignition lock	65		
	Starting the engine	65		
	Switching off the engine	67		
	Parking brake	67		
	Manual transmission	68		
	Sequential manual gearbox SMG*	69		
	Automatic transmission with Steptronic*	73		
	Turn signal indicator/Headlamp flasher	76		
	Washer/wiper system/Rain sensor*	77		
Cruise control*	78			
	<b>Everything under control:</b>			
	Odometer	80		
	Tachometer	80		
	Energy control	80		
	Fuel gauge	81		
	Engine coolant temperature gauge	81		
	Service interval display	82		
	Check Control	82		
	Clock	83		
	Computer*	84		
	<b>Technology for safety and driving convenience:</b>			
	Park Distance Control (PDC)*	86		
	Dynamic Stability Control (DSC)	87		
	Dynamic Stability Control (DSC) – 325xi, 330xi	89		
	Hill Descent Control (HDC)*	91		
	Flat Tire Monitor*	92		
	Brake force display	93		
	<b>Lamps:</b>			
	Parking lamps/Low beams	94		
	Instrument lighting	95		
	High beams/Standing lamps	95		
	Fog lamps*	96		
	Interior lamps	96		
	<b>Controlling the climate for pleasant driving:</b>			
	Air conditioning	98		
	Automatic climate control*	102		
	Roller sun blind*	106		
	<b>Interior conveniences:</b>			
	Premium sound system*	107		
	Glove compartment	107		
	Storage compartments	108		
	Cellular phone*	110		
	Ashtray, front*	110		
	Ashtray, rear*	111		
	<b>Loading and transporting:</b>			
	Through-loading system*	112		
	Ski bag*	113		
	Cargo loading	114		
	Roof-mounted luggage rack*	117		

# Contents

## Operation, maintenance

### Special operating instructions:

- Break-in procedures 120
- General driving notes 121
- Antilock Brake System (ABS) 121
- Brake system 122

### Wheels and tires:

- Tire inflation pressure 124
- Tire condition 124
- Tire replacement 125
- Wheel and tire combinations 127
- Winter tires 127

### In the engine compartment:

- Hood 129
- Engine compartment essentials 130
- Washer fluids 132
- Engine oil 132
- Coolant 134
- Brake fluid 134

### Maintenance:

- The BMW Maintenance System 136

### Laws and regulations:

- California Proposition 65 warning 138
- OBD interface socket 138

## Owner service procedures

### Replacement procedures:

- Onboard tool kit 142
- Windshield wiper blades 142
- Lamps and bulbs 143
- Changing a wheel 147
- Run Flat tires\* 150
- Battery 151
- Fuses 151

### Giving and receiving assistance:

- Receiving assistance 152
- Jump-starting 153
- Towing the vehicle 154

## Technical data

- Engine data 160
- Dimensions 161
- Weights 162
- Capacities 163

# Contents

<b>Index</b>	Everything from A to Z	166
--------------	------------------------	-----



## Overview

Controls and features

Operation, maintenance

Owner service procedures

Technical data

Index



## 14 Cockpit

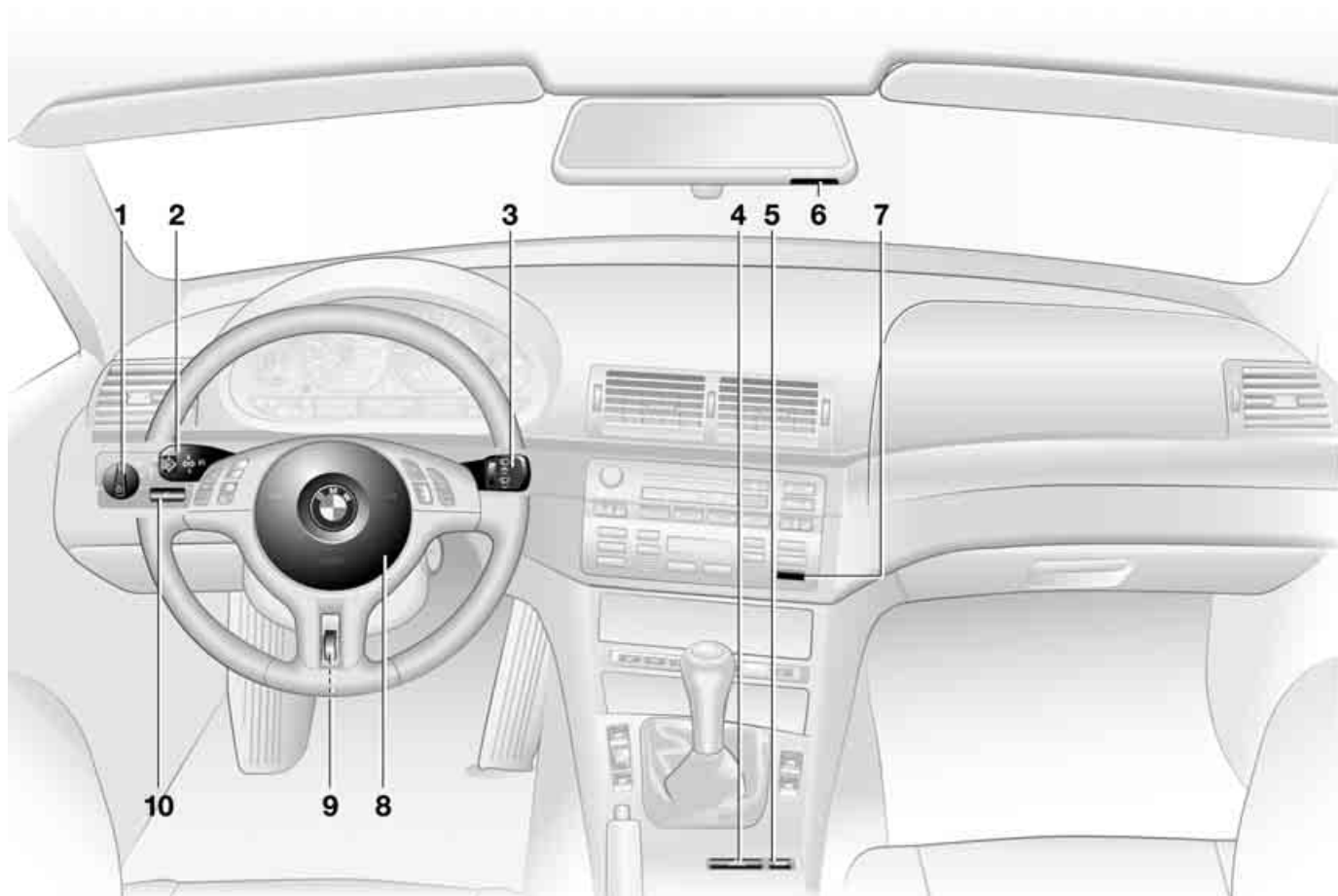

# Cockpit

- 1 Parking lamps/Low beams 94
- 2 ▷ Turn signal indicators 76
  - ▷ Standing lamps 95
  - ▷ High beams 95
  - ▷ Headlamp flasher 76
  - ▷ Computer 84
- 3 Washer/wiper system/Rain sensor 77
- 4 Hazard warning flashers
- 5 Central locking system 32
- 6 ▷ Initiating an emergency call 152
  - ▷ Mobile Service 152
- 7 Rear window defroster 100, 105
- 8 Horn: the entire surface
- 9 Adjusting the steering wheel 55
- 10 Fog lamps 96

## 16 Instrument cluster

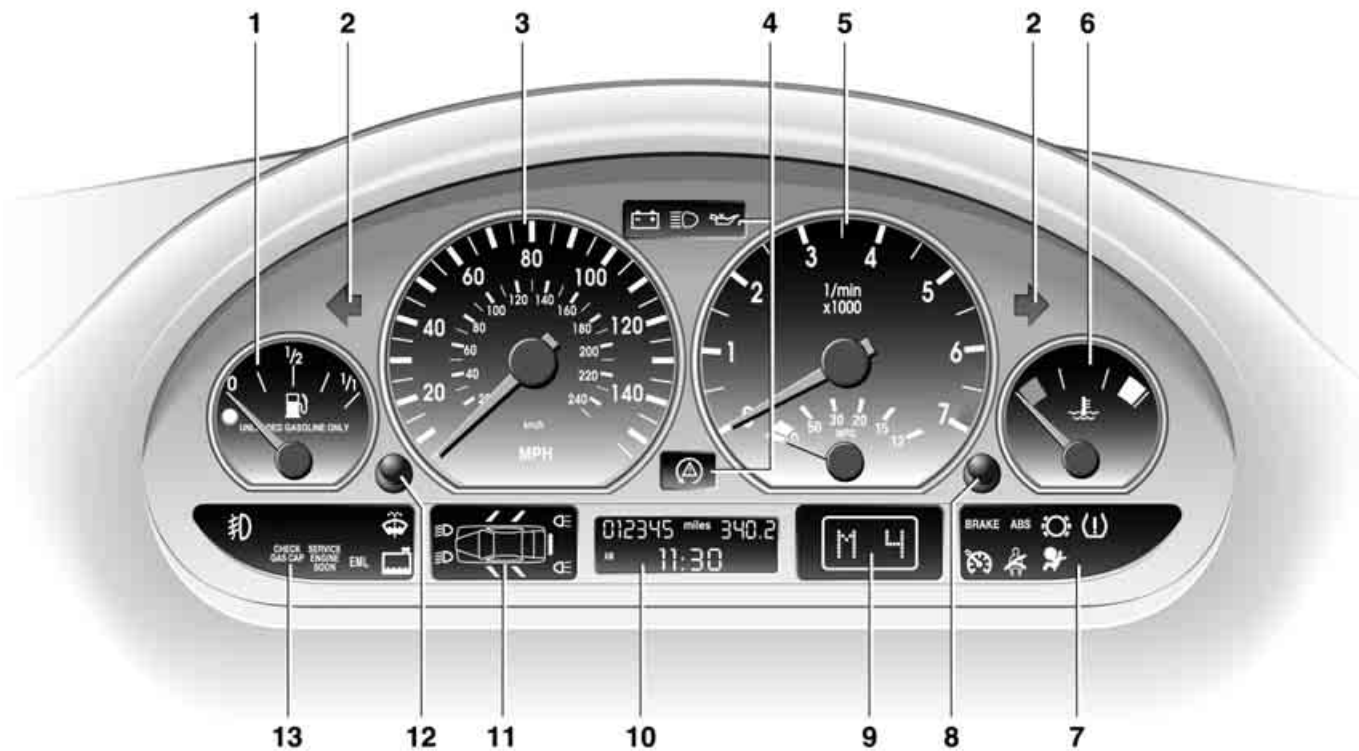



# Instrument cluster

- 1 Fuel gauge 81
- 2 Indicator lamp for turn signals 20
- 3 Speedometer
- 4 Indicator and warning lamps 18 to 21
- 5 Tachometer and Energy Control 80
- 6 Engine coolant temperature gauge 81
- 7 Indicator and warning lamps 18 to 21
- 8 Control button for the clock 83
- 9 Selector lever and program display for automatic transmission/sequential manual gearbox 19, 69, 75
- 10 Display for
  - ▷ Trip odometer/Odometer 80
  - ▷ Clock 83
  - ▷ Service interval 82
  - ▷ Computer 84
- 11 Check Control 82
- 12 Trip odometer, reset to zero 80
- 13 Indicator and warning lamps 18 to 21

## 18 Indicator and warning lamps

### Technology that monitors itself

Indicator and warning lamps that are identified by ● are tested for proper functioning whenever the ignition key is turned. They each light up once for different periods of time.

If a fault should occur in one of these systems, the corresponding lamp does not go out after the engine is started, or it lights up while the vehicle is moving. You will see how to react to this below.

### Red: stop immediately

 Battery charge current ●  
The battery is no longer being charged. Indicates a defective alternator drive belt or a problem with the alternator's charge circuit. please contact the nearest BMW center.

 If the drive belt is defective, stop and switch off the engine immediately to prevent overheating and serious engine damage. If the drive belt is defective, increased steering effort is also required. ◀

 Engine oil pressure ●  
Stop the vehicle immediately and switch off the engine. Check the engine oil level; top off as required. If the oil level is correct: please contact the nearest BMW center.



 Do not continue driving, as the engine could sustain serious damage from inadequate lubrication. ◀

 Brake warning lamp ●  
If the lamp comes on when the parking brake is not engaged: check the brake fluid level. Before driving further, be sure to comply with the instructions on pages 122 and 134.

 Brake warning lamp for Canadian models.

 Flat Tire Monitor ●  
In addition, an acoustic signal is sounded: there is a flat tire. Reduce speed and carefully come to a stop. Avoid sudden braking and steering maneuvers. For additional information: refer to page 92

### Red and yellow: continue driving cautiously

 The brake warning lamp comes on together with the yellow indicator lamps for ABS ● and DSC:  
 The entire ABS, CBC, DSC and ADB-X/DBC control system has failed. Continue driving cautiously and defensively. Avoid hard brake applications. Please have the system checked by your BMW center as soon as possible. Additional information beginning on page 86

 CBC, ABS, DSC and ADB-X/DBC indicator and warning lamps for Canadian models.



### Red: an important reminder

 Brake warning lamp  
Comes on when the parking brake is engaged – an additional acoustic signal sounds when starting off. For additional information: refer to page 67

## Indicator and warning lamps



Brake warning lamp for Canadian models.



Please fasten safety belts ●

Comes on together with an acoustic signal until the safety belts are fastened.

For additional information on safety belts: refer to page [51](#)



Airbags ●

Please have the system inspected by your BMW center.

For additional information: refer to page [57](#)

### Orange: consult the nearest BMW center



Automatic transmission/sequential manual gearbox

The respective transmission has responded to a malfunction by reverting to operation in its emergency default program. Please consult the nearest BMW center.

For additional information: refer to pages [69](#), [73](#)

### Yellow: check as soon as possible



Engine oil level

If the lamp comes on during normal vehicle operation: the engine oil level has fallen to the absolute minimum; refill as soon as possible. Do not drive more than approx. 30 miles/50 km before refilling. For additional information: refer to page [132](#)



Engine oil level

Comes on after the engine has been switched off: add engine oil at your earliest opportunity, such as when you next stop to refuel. For additional information: refer to page [132](#)



Brake pads ●

Have the brake pads checked. For additional information: refer to page [122](#)



Flat Tire Monitor ●

The Flat Tire Monitor is malfunctioning or out of order. Please have the system inspected by your BMW center. For additional information: refer to page [92](#)



Dynamic Stability Control (DSC) ●

Indicator lamp flashes:

The system is actively regulating drive torque and braking force.

The indicator lamp stays lit:

DSC has been switched off with the button; DTC is operational. Please consult the nearest BMW center in case of a malfunction.

Additional information beginning on page [86](#)

325xi, 330xi:

DSC has been switched off manually or there is a system malfunction.

ADB-X is operational in its standby mode. If the indicator lamp fails to go out when you press the DSC button again, this indicates a system malfunction affecting both DSC and ADB-X. Please consult the nearest BMW center.

For additional information: refer to page [89](#)

## 20 Indicator and warning lamps



Dynamic Stability Control (DSC) and brake warning lamp ●

The indicator lamps remain on: DSC/DTC have been switched off with the button or are faulty. Please consult the nearest BMW

center.

Additional information beginning on page [86](#)

325xi, 330xi:

DSC and ADB-X system malfunction. There is no provision for deactivating ADB-X.

Please consult the nearest BMW center.

For additional information: refer to page [89](#)



DSC indicator and brake warning lamps for Canadian models.



Dynamic Brake Control (DBC) ●  
Malfunction in DBC system.

Conventional braking efficiency is available and unrestricted.

Have the system repaired at your BMW center as soon as possible.

For additional information: refer to page [121](#)

**BRAKE**



Dynamic Brake Control (DBC) warning lamp for Canadian models.



Add washer fluid  
The washer fluid level is too low. Top off the fluid at the earliest opportunity.

For additional information: refer to page [132](#)



CHECK GAS CAP\* ●  
This indicator lamp comes on when the fuel filler cap is loose or missing.

Close the gas cap tightly: refer to page [24](#)



SERVICE ENGINE SOON ●  
If the indicator lamp comes on either continuously or intermittently, this indicates a fault in the emissions-related electronic systems. Although the vehicle remains operational, you should have the systems checked by your BMW center at the earliest possible opportunity.

For additional information: refer to page [138](#)



Service Engine Soon indicator lamp for Canadian models.



Engine electronics ●  
There is a fault in the electronic engine-management system.

You can continue to drive with reduced engine output or engine speed. Please have the system inspected by your BMW center.



Add coolant  
The coolant level is too low. Add coolant at the earliest opportunity.

For additional information: refer to page [134](#)

### Green: for your information



Turn signal indicator  
Flashes when the turn signals are on.

Rapid flashing indicates a system malfunction.

For additional information: refer to page [76](#)



Cruise control  
Lights up when the cruise control is activated: ready for operation via the buttons in the steering wheel.

For additional information: refer to page [78](#)

## Indicator and warning lamps



Front fog lamps  
Lights up whenever you switch  
on the fog lamps.

For additional information: refer to  
page [96](#)

### Blue: for your information



High beams  
Comes on when the high beams  
are on or the headlamp flasher  
is actuated.

For additional information: refer to  
pages [76](#), [95](#)

## 22 Buttons in steering wheel\*

These buttons let you operate the following functions quickly and without being distracted from traffic conditions:

- ▷ Selected radio functions
- ▷ The cruise control
- ▷ Selected telephone functions
- ▷ The voice recognition system.

 The controls are active only when the corresponding systems and accessories are switched on. ◀



Press briefly: receive a phone call, initiate dialing, terminate a call.

Extended pressure:

Switch voice recognition on and off.



Switch between phone, radio, cassette and CD.



Forward:

- ▷ Radio  
Press briefly: next station in station memory  
Extended pressure: station search

- ▷ CD  
Press briefly: jump to next track  
Extended pressure: search function in track
- ▷ Cassette  
Press briefly: jump to next track or stop fast forward  
Extended pressure: fast forward
- ▷ Phone  
Scan personal phone book.



Rewind: same functions as forward.



Volume.



Cruise control: select a stored setting.



Cruise control: store and accelerate + or decelerate and store -.

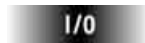

Cruise control: activate/interrupt/deactivate.

## Hazard warning triangle\*



The hazard warning triangle is stored in a storage case on the left side of the luggage compartment.

 Always observe all legal regulations requiring a warning triangle to be carried in the vehicle. ◀

## First-aid kit\*

23



The first-aid kit is located under the passenger seat.

To release: pull the handle and fold the cover down.

To close: fold the cover up and press it until the tab engages.

 Some of the articles in the first-aid kit have a limited period of use before expiration. For this reason, check the expiration dates of each of the items regularly and replace any whose expiration dates have passed. You can purchase replacements in any drugstore or pharmacy. Always observe all legal regulations requiring a first-aid kit to be carried in the vehicle. ◀

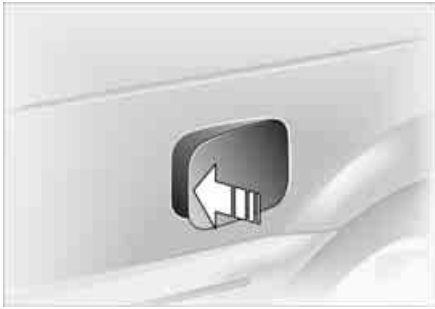

### **Fuel filler door**

 Always switch off the engine before refueling, as it is not possible to add fuel with the engine running, and attempts may also trigger the SERVICE ENGINE SOON lamp. ◀

Press on the rear edge of the fuel filler door to open and close it.

If an electrical malfunction occurs, you can unlock the fuel filler door manually: Pull the knob with the fuel pump symbol, located on the right side wall of the luggage compartment.

 Always observe all safety precautions posted at the service station when handling fuel. Never carry spare fuel containers in your vehicle. Whether empty or full, these containers can leak, cause an explosion, or lead to fire in the event of a collision. ◀

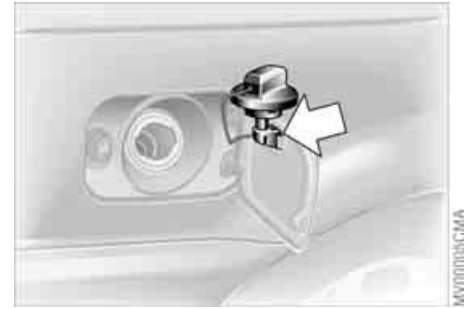

### **Simple and environmentally friendly**

 Open the gas cap carefully to prevent fuel from spraying out. Fuel spray may cause injury. ◀

Keep the gas cap in the bracket attached to the fuel filler door.

When refueling, insert the filler nozzle completely into the filler pipe. Lifting the nozzle during refueling

- ▷ results in premature pump shutoff
- ▷ and will reduce the effectiveness of the vapor recovery system on the pump.

The fuel tank is full when the filler nozzle shuts off the first time.



## Refueling

 Close the gas cap carefully after refueling until a click is heard. While closing, be sure not to squeeze the strap which is fastened to the cap. A loose or missing cap will activate the CHECK GAS CAP\* lamp. ◀

### Tank capacity

▷ Approx. 16.6 gal./63 liters, of which  
▷ approx. 2.1 gal./8 liters are reserve capacity.

 Do not drive to the last drop of fuel. This can prevent the engine from operating properly and result in damage. ◀

## Fuel specifications

The engine uses lead-free gasoline only.

Required fuel:

▷ Premium Unleaded Gasoline, min. 91 AKI.  
AKI = Anti Knock Index

 Never use leaded fuel, as it would cause permanent and irreversible damage to the oxygen sensor and the catalytic converter. ◀

## Tire inflation pressure

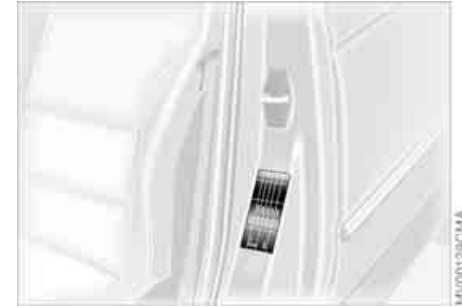

### Checking tire pressures

Tire pressures in psi/kilopascal are shown on the driver's door post and are visible when the door is open.

Only check the tire inflation pressures of cold tires. This means after driving a maximum of 1.25 miles/2 km or after the vehicle has been parked for at least 2 hours. Warm tires have higher inflation pressures.

In the following tire inflation pressure table, all pressures are specified in the standard units of pressure, psi and kilopascal, and apply to cold tires, i.e. tires at ambient temperature.

## 26 Tire inflation pressure

Vehicles with Flat Tire Monitor:

After correcting the inflation pressures, reinitialize the system. Refer to page 92.



Check the tire pressures on a regular basis – at least twice a month – and before every extended journey. If this is not done, incorrect tire pressures can cause driving instability and tire damage, ultimately resulting in accidents.

Remember to check the inflation pressure in the space-saver or standard spare tire.

Inflate the spare tire to the highest inflation pressure specified for your vehicle. ◀

### **Comply with tire approval specifications**

The inflation pressures in the table apply to BMW approved tire sizes and tire manufacturers. Your BMW center can provide you with more information about these. Other pressures may be required for tires made by other manufacturers.

Your vehicle is equipped with tires that not only meet US standards, but also European standards. We recommend the exclusive use of BMW approved tires.

## BMW Tires

All pressure specifications in the table are indicated in psi/kilo-pascal with cold tires  
cold = ambient temperature



320i	205/55 R 16 91 H M+S, 205/55 R 16 91 H, 225/50 R 16 92 W, 225/45 R 17 91 W	29/200	33/230	33/230	41/280
	225/45 ZR 17	29/200	–	33/230	–
	245/40 ZR 17	–	33/230	–	41/280
	205/50 R 17 93 V M+S extra load, 205/50 R 17 93 W extra load, 195/65 R 15 91 Q M+S, 205/60 R 15 91 Q M+S, 205/55 R 16 91 Q M+S, 225/50 R 16 92 Q M+S, 205/50 R 17 93 Q M+S extra load, 225/45 R 17 91 Q M+S	32/220	36/250	36/250	44/300
325i	205/55 R 16 91 H M+S, 205/55 R 16 91 H,	30/210	35/240	35/240	42/290
325xi	225/50 R 16 92 W – not 325xi, 225/45 R 17 91 W				
	225/45 ZR 17	30/210	–	35/240	–
	245/40 ZR 17	–	35/240	–	42/290
	205/50 R 17 93 V M+S extra load, 205/50 R 17 93 W extra load, 205/55 R 16 91 Q M+S, 225/50 R 16 92 Q M+S – not 325xi, 205/50 R 17 93 Q M+S extra load, 225/45 R 17 91 Q M+S	33/230	38/260	38/260	45/310
330i	205/50 R 17 93 V M+S extra load, 205/50 R 17 93 W extra load, 205/50 R 17 93 Q M+S extra load, 225/45 R 17 91 Q M+S, 225/45 R 17 91 W	32/220	38/260	39/270	46/320
	225/45 ZR 17	32/220	–	39/270	–
	245/40 ZR 17	–	38/260	–	46/320
	225/40 ZR 18	32/220	–	39/270	–
	255/35 ZR 18	–	38/260	–	46/320

## 28 Tire inflation pressure

### BMW Tires

All pressure specifications in the table are indicated in psi/kilo-pascal with cold tires  
cold = ambient temperature



330xi	225/45 R 17 91 W	30/210	35/240	35/240	42/290
	225/45 ZR 17	30/210	-	35/240	-
	245/40 ZR 17	-	35/240	-	42/290
	205/50 R 17 93 V M+S extra load, 205/50 R 17 93 W extra load, 205/55 R 16 91 Q M+S, 205/50 R 17 93 Q M+S extra load	33/230	38/260	38/260	45/310
All	Space-saver spare tire			61/420	



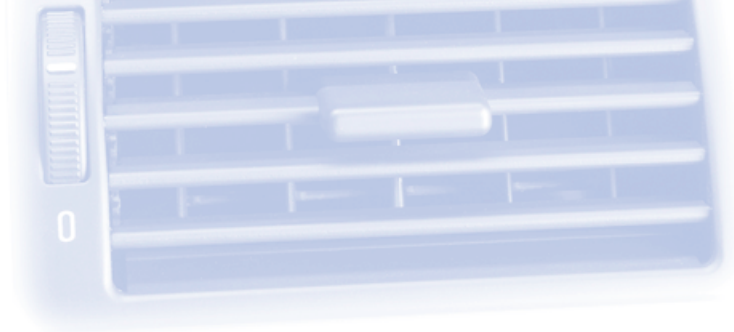

Overview

**Controls and features**

Operation, maintenance

Owner service procedures

Technical data

Index

Overview

Controls

Maintenance

Repairs

Data

Index



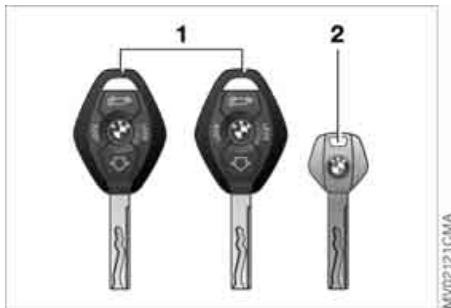

### The key set

- 1 Master keys with remote control unit – these keys determine the functions of the Key Memory. Refer to page 64. You can mark the individual keys for subsequent identification by applying the colored decals that you received when accepting delivery of your vehicle

 In every master key there is an extended-life battery that is charged automatically in the ignition lock as you drive.

For this reason, if you have master keys that are not being used otherwise, use those keys at least once a year while driving for an extended period to charge the battery. ◀

- 2 Spare key – for storage in a safe place, such as in your wallet. This key is not intended for constant use. The luggage compartment lid and the glove compartment cannot be locked and unlocked with this key. This is useful for valet parking, for example

## Central locking system

### The concept

The central locking system is ready for operation whenever the driver's door is closed. The system simultaneously engages and releases the locks on the

- ▷ doors
- ▷ luggage compartment lid
- ▷ fuel filler door.

The central locking system can be operated

- ▷ from outside via the remote control as well as via the driver's door lock
- ▷ from inside by pressing a button.

The fuel filler door is not locked when the central locking system is activated from the inside, refer to page 37. When the system is actuated from the outside, the anti-theft system is also activated. This prevents the doors from being unlocked via the lock buttons or the release handle. The alarm system is also activated or deactivated.

If locked from the inside, the central locking system unlocks automatically in the event of an accident, except on doors that have been locked individually using the lock buttons, refer to page 39. In addition, the hazard warning flashers and interior lamps come on.



# Opening and closing – via the remote control

## The concept

The remote control also provides two additional functions beyond the central locking feature:

- ▷ To switch on interior lamps, refer to page 34.  
With this function you can also search for your vehicle when parked in an underground garage, for instance
- ▷ To open the luggage compartment lid, refer to page 34.  
The luggage compartment lid will open slightly, regardless of whether it was previously locked or unlocked.

Whenever you unlock or lock the vehicle, you simultaneously deactivate/activate the anti-theft system, disarm/arm the alarm system and switch the interior lamps on/off.



You can have a signal set to confirm that the vehicle's locks have engaged securely. ◀

## Master keys with remote control



Persons or animals inside the vehicle may be able to lock the doors from the inside. For this reason, always take the vehicle keys with you so that the vehicle can be opened again from the outside at any time. ◀



If it is no longer possible to lock the vehicle via the remote control, the battery is discharged. Use this key while driving for an extended period in order to recharge the battery. To prevent unauthorized use of the remote control, surrender only the spare key when leaving the vehicle for valet parking, for example. In the event of a system malfunction, please contact your BMW center. You can also obtain replacement keys there. ◀



- 1 Unlock, convenience opening mode, and disarm alarm system
- 2 Lock and secure, arm alarm system, activate interior lamps, disarm tilt alarm sensor and interior motion sensor
- 3 Open the luggage compartment lid, panic mode – trigger alarm

## To release



Press the button once to unlock the driver's door.

Press the button a second time to disengage all vehicle locks.

## 34 Opening and closing – via the remote control

### Convenience opening mode



Press and hold button: to open the electric power windows and glass sun-roof.

### To lock and secure



Press button.

### To switch on the interior lamps



With the vehicle locked, press button.

### To deactivate the tilt alarm\* and interior motion sensors\*



Press button a second time immediately after locking.

For additional information, refer to page [42](#).

### To open the luggage compartment lid



Press button.

The luggage compartment lid will open slightly, regardless of whether it was previously locked or unlocked.

 If the luggage compartment lid was locked, it will be locked again after it is reclosed.

Before and after a trip, be sure that the luggage compartment lid has not been opened unintentionally. ◀

### Panic mode – trigger alarm



Provided that the alarm system is armed, you can respond to imminent danger by holding down the button for more than 2 seconds.

To switch off the alarm:



Press button.

### External systems

The remote control system's operation may be affected by other units or equipment operating in the immediate vicinity of your vehicle.

If this should occur, you can still open and close the vehicle using the master key in either the door or luggage compartment lid locks.

### For US owners only

The transmitter and receiver units comply with part 15 of the FCC Federal Communications Commission regulations. Operation is governed by the following:

FCC ID:

- ▷ LX8EWS
- ▷ LX8FZVS
- ▷ LX8FZVE.

Compliance statement:

This device complies with part 15 of the FCC Rules. Operation is subject to the following two conditions:

- ▷ This device may not cause harmful interference, and
- ▷ this device must accept any interference received, including interference that may cause undesired operation.

# Opening and closing – via the remote control



Any unauthorized modifications to these devices could void the user's authority to operate the equipment. ◀

## 36 Opening and closing – via the door lock

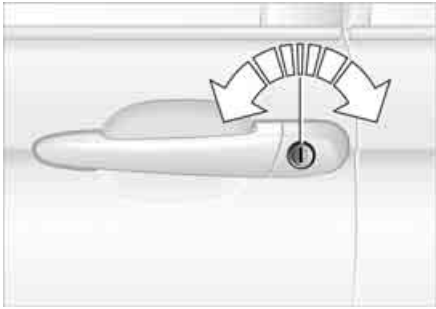

 Whenever closing the windows or sliding/tilt sunroof you should always monitor their path and progress to ensure that no one is injured. Release the key to stop the windows or sliding/tilt sunroof. ◀

### Manual operation

In the event of electrical malfunction  
Turn the key all the way to the left or right to unlock or lock the driver's door.

One turn of the key in the driver's door lock unlocks the driver's door only. Turning the key a second time unlocks all of the remaining doors, the luggage compartment lid and the fuel filler door.



You can have a signal set to confirm that the vehicle's locks have engaged securely. ◀

### Convenience operation

You can also operate the power windows and the glass sunroof via the door lock.

- ▷ To open: with the door closed, hold the key in the Unlock position
- ▷ To close: with the door closed, hold the key in the Lock position.

## Opening and closing – from the inside



You can use this button to control the central locking system whenever the doors are closed. The doors and luggage compartment lid are unlocked or locked only. The anti-theft system is not activated.

 If only the driver's door was unlocked from the outside and you press the button, then, with the driver's door still open, the passenger-side door, the luggage compartment lid and the fuel filler door will unlock, too. If the driver's door is closed, it will be locked. ◀

 If you desire, the central locking system can be activated automatically as soon as you begin to drive. This can be adjusted to be key-specific. ◀

### To unlock and open the doors

1. Press the button for the central locking system
2. Pull the release handle above the armrest on the door you wish to open

or

pull the release handle for any door twice: to unlock and open the door.

### To lock

- ▷ Either use the central locking button to lock all doors at once or
- ▷ press down the individual door lock buttons. The fuel filler door remains unlocked. To prevent the driver from being inadvertently locked out of the vehicle, the driver's door lock button will not engage as long as the door is open.

 Persons or animals inside the vehicle may be able to lock the doors from the inside. For this reason, always take the vehicle keys with you so that you can open the vehicle again from the outside at any time. ◀

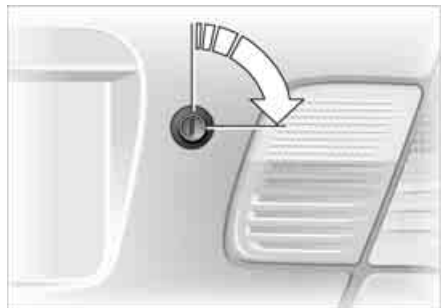
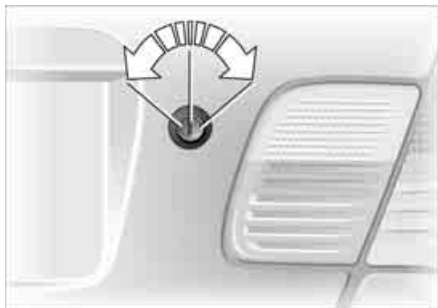

### **The lock**

Only the master keys fit in the lock for the luggage compartment lid, refer to page 32.

### **To secure separately**

Turn the master key to the right past the resistance point and then pull it out in the horizontal position.

This locks the luggage compartment lid and disconnects it from the central locking system. This feature can be used to prevent unauthorized access to the luggage compartment when you surrender the spare key only, refer to page 32. This can be advantageous for valet parking, for example.

### **To open from the outside**

Press the button in the handle recess: the luggage compartment lid opens slightly.

The luggage compartment is lit when the luggage compartment lid is opened.

### **Manual operation**

In the event of electrical malfunction  
Turn the master key all the way to the left – the luggage compartment lid will open slightly.

The luggage compartment lid is locked again as soon as you close the lid.

To open from the inside, refer to the following section.

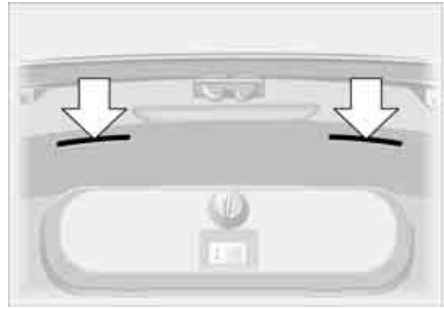



## To open from the inside\*

If the luggage compartment lid has not been locked separately, you can open it with this button in the footwell on the driver's side when the vehicle is stationary.

## To close

The handle recesses in the interior trim panel of the luggage compartment lid make it easier to pull the lid down.

 To avoid injuries, be sure that the travel path of the luggage compartment lid is clear when it is closed, following the same precautions as with all closing procedures. ◀

 Operate the vehicle only when the luggage compartment lid is closed. Otherwise, exhaust fumes could penetrate the interior of the vehicle. ◀

Should it be absolutely necessary to operate the vehicle with the luggage compartment lid open:

1. Close all windows and the glass sunroof
2. Greatly increase the quantity of air coming from the air conditioning or automatic climate control system, refer to page 98 or 102.

## 40 **Luggage compartment lid**



### **Emergency release**

This lever releases the luggage compartment lid from the luggage compartment's interior.

## **Luggage compartment**

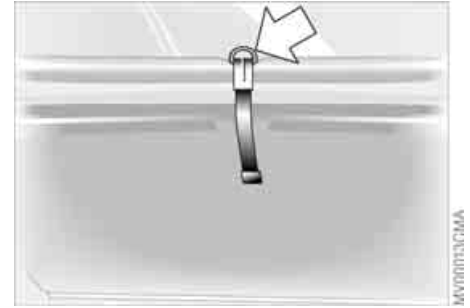

### **Floor panel**

Lift the floor panel with the ring, then use the tab to suspend it from the weather-stripping on the drip rail.



## Luggage compartment

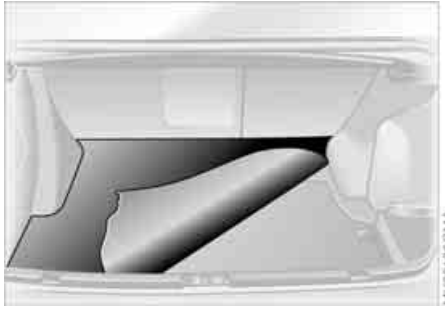

### Floor mat

You can turn the floor mat over to transport soiled objects, etc. The rubber-coated side is suitable for washing and is also designed to inhibit sliding.

The fittings at the corners of the luggage compartment provide you with a convenient means of attaching luggage compartment nets\* and flexible straps for securing luggage.

Refer also to Cargo loading on page 114.

## Alarm system\*

### The concept

The vehicle alarm system responds:

- ▷ When a door, the hood or the luggage compartment lid is opened
- ▷ To movement inside the vehicle – interior motion sensor
- ▷ To variations in the vehicle's tilt angle such as those occurring during attempts to steal the wheels or tow the vehicle – tilt alarm sensor
- ▷ To interruption of battery voltage.

The system responds to unauthorized vehicle entry and attempted theft by simultaneously activating the following:

- ▷ The acoustic alarm sounds for 30 seconds
- ▷ The hazard warning flashers are activated for approx. five minutes
- ▷ The high beams flash on and off in rhythm with the hazard warning flashers.

### To arm and disarm the alarm system

When the vehicle is locked or unlocked via the driver's door lock or with the remote control, the alarm system is also simultaneously armed or disarmed.



You can have different acknowledgment signals set to confirm arming and disarming. ◀



You can also open the luggage compartment lid when the system is armed by pressing the remote control button, refer to page 34. The lid is once again secured when it is closed.

Extended pressure on the button sets off the alarm – Panic mode, refer to page 34.



### Indicator lamp displays

- ▷ The indicator lamp below the interior rearview mirror flashes continuously: the system is armed
- ▷ The indicator lamp flashes during arming: a door, the hood or luggage compartment lid is not completely closed. Even if you do not close the alerted area(s), the remaining areas are secured, and the indicator lamp will flash continuously after 10 seconds. However, the interior motion sensor is not activated
- ▷ If the indicator lamp goes out when the system is disarmed: no manipulation or attempted intrusions have been detected in the period since the system was armed
- ▷ If the indicator lamp flashes for 10 seconds when the system is dis-

armed: an attempted entry has been detected in the period since the system was armed.

Following triggering of an alarm, the indicator lamp will flash continuously.

### Avoiding unintentional alarms

The tilt alarm sensor and interior motion sensor may be switched off at the same time. You can do this to prevent a false alarm from being triggered in garages with elevator ramps, for instance, or when the vehicle is transported by train:



Lock the vehicle twice, i.e. arm the system. Press button on the remote control twice in succession or lock the vehicle twice with the key.

The indicator lamp lights up briefly and then flashes continuously. The tilt alarm sensor and interior motion sensor are deactivated for as long as the system remains armed.



You can have the tilt alarm sensor and the interior motion sensor permanently deactivated. ◀

### Interior motion sensor

In order for the interior motion sensor to function properly, the windows and the glass sunroof must be completely closed.

Nevertheless, you should deactivate the interior motion sensor, refer to Avoiding unintentional alarms, if

- ▷ persons or animals are left in the vehicle
- ▷ the windows or the glass sunroof are being left open.



The system deactivates the tilt-alarm sensor and the interior motion sensor if the convenience closing of windows is interrupted in the first 10 seconds and then restarted. The alarm must then be disarmed and reactivated before it will resume operation. ◀

# Electric power windows



MAV00662CMA

- ▷ Press the switch briefly past the pressure point: the window moves automatically. Pressing the switch again stops the opening cycle.

You can close the windows in the same manner by pulling the switch.

Separate switches are located under the windows in the rear passenger area.

For convenience operation via the remote control or the door lock, refer to page 34 or 36.

## To open and close windows

 When leaving the vehicle, always remove the ignition key from the lock and remember to close the doors to prevent children from operating the power windows and injuring themselves, etc. ◀

After the ignition has been switched off: You can still operate the electric power windows for up to 15 minutes, as long as no one opens either of the front doors.

With the ignition key in position 1 or higher:

- ▷ Press the switch until you feel resistance: the window retracts as long as you maintain pressure on the switch

## Safety feature

A contact strip is located on the inside upper frame of each of the front windows. If pressure is exerted against this contact strip while a window is being raised, the system will respond by stopping the window and then retracting it a small distance.

 Despite this safety feature, be extremely careful to ensure that the closing path of the window is not obstructed. Some types of objects might fail to trigger the contact strip in some situations – very thin objects, for instance.

You can override this safety feature by pressing the switch beyond the resistance point and holding it. ◀

## 44 Electric power windows



### Safety switch

With the safety switch, you can prevent the rear windows from being opened or closed via the switch in the rear passenger area – by children, for example.

 Press the safety switch whenever children are riding in the rear of the vehicle. Careless use of the power windows can lead to injury. ◀

## Glass sunroof, electric\*

 To prevent injuries, exercise care when closing the glass sunroof and keep it in your field of vision until it is shut.

When leaving the vehicle, always extract the ignition key from the lock and remember to close the doors to prevent children from operating the sunroof and injuring themselves, etc. ◀

## Glass sunroof, electric\*

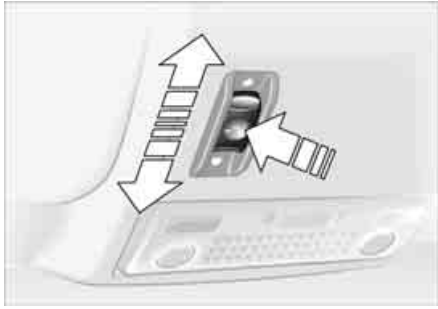

### Opening and closing

With the ignition key in position 1 or higher

- ▷ Slide the switch until you feel resistance: the sunroof opens and closes as long as you hold the switch
- ▷ Slide the switch past the pressure point: the sunroof moves automatically.

Tapping the switch again stops the motion immediately.

The headliner insert retracts with the sunroof while it is opening.

After the ignition has been switched off: you can still operate the sunroof for up to 15 minutes, as long as no one opens either of the front doors.

For convenience operation via the remote control or the door lock, refer to page 34 or 36.

### Raising the glass sunroof

With the ignition key in position 1 or higher: tap the switch.

Tapping the switch again stops the motion immediately.

If you briefly press the switch in the raise direction while the sunroof is open, the sunroof will rise to its uppermost position.

After the ignition has been switched off: you can still operate the sunroof for up to 15 minutes, as long as no one opens either of the front doors.

The headliner insert slides back somewhat when you raise the sunroof.

 Do not use force to close the headliner insert with the sunroof in its raised position, as damage to the mechanism could result. ◀

### Safety feature

If the glass sunroof encounters resistance

- ▷ when it is closing from the raised position

▷ when it is closing from a point roughly past the middle of its travel the closing cycle is interrupted and the glass sunroof will open again slightly.

 Despite this safety feature, be extremely careful that the travel path of the sunroof is not obstructed whenever it is closed. Remember that the safety mechanism may not be able to detect obstructions under all circumstances – with very thin objects, for instance.

You can disable this safety feature by pressing the switch beyond the pressure point and holding it. ◀

## 46 Glass sunroof, electric\*

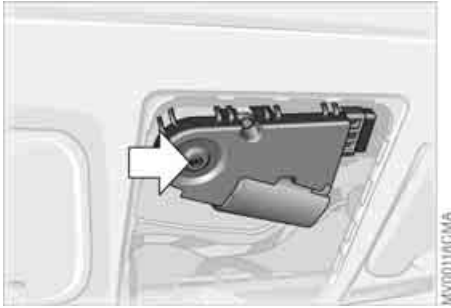

### Manual operation

In the event of an electrical malfunction, you can also operate the glass sunroof manually

1. Remove the interior lamp, then reach into the exposed opening and press out the cover
2. Use the Allen key from the onboard tool kit, refer to page 142, to turn the glass sunroof in the desired direction.

## Safe seating position

For driving that is relaxed and less likely to cause fatigue, you should select a sitting position that reflects your personal requirements. In combination with the safety belts and airbags, the correct seating position also plays an important role in enhancing occupant safety in the event of an accident. To ensure that the vehicle's safety systems provide you with optimal protection, we request that you direct your careful attention to the following section.

For supplementary information on transporting children, refer to page 60.

### Sitting safely with airbags

 Always maintain an adequate distance between yourself and the airbags. Always hold the steering wheel by the rim to keep any chance of injury to hands or arms to an absolute minimum should the airbag be deployed. Never allow any objects, individuals or animals to obstruct the areas between passengers and airbags. Never use the front airbag's cover as a storage tray or support for objects of any kind. Never allow front passengers to rest their feet or legs on the airbag cover. ◀

For airbag locations and additional information on airbags, refer to page 57.

### Sitting safely with safety belts

Your vehicle offers five sitting positions, each of which is provided with a safety belt.



Never allow more than one person to wear a single safety belt. Never allow infants or small children to ride in a passenger's lap. Avoid twisting the belt while routing it firmly across the hips and shoulder, wear it as snugly against your body as possible. Do not allow the belt to rest against hard or fragile objects. Do not route the belt across your neck, or run it across sharp edges. Be sure that the belt does not become caught or jammed. Avoid wearing bulky clothing and pull on the lap belt periodically to retension it over your shoulders. In the event of a frontal impact, a loose lap belt could slide over your hips, leading to abdominal injury. In addition, the safety belt's restraint effectiveness is reduced if it is worn loosely. Expectant mothers should always wear their safety belts, taking care to position the lap belt against the lower hips, where it will not exert pressure against the abdominal area. ◀

For information on using the safety belts, refer to page 51.

## Manual seat adjustment

### When adjusting your seat, always observe the following precautions

 Never try to adjust your seat while operating the vehicle. The seat could respond with unexpected movement, and the ensuing loss of vehicle control could lead to an accident. Never ride with the backrest reclined to an extreme angle. This is especially important for the front passenger to remember. If you do so, there is a risk that you will slide under the safety belt in an accident, thus reducing the protection provided by the safety belt. ◀

### Seat adjustment

- ▷ Manual seat adjustment, refer to page 48
- ▷ Power seat adjustment, refer to page 50
- ▷ Head restraint, refer to page 51.

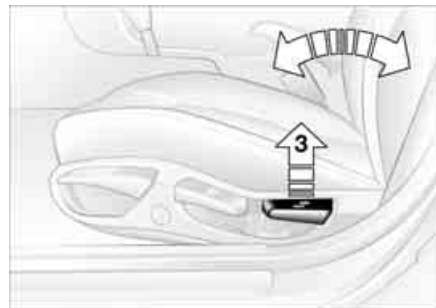
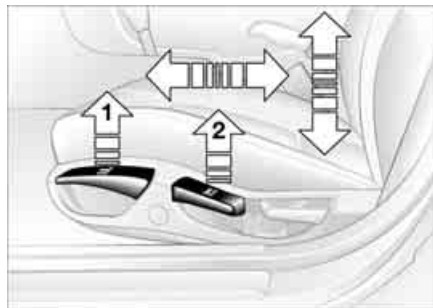

### Seat adjustment

- 1 **Backward/Forward adjustment**  
Pull the lever and slide the seat to the desired position.  
After you release the lever, move the seat forward or backward slightly so that it engages fully
- 2 **Height**  
Pull the lever and apply weight to or remove weight from the seat as required
- 3 **Backrest angle**  
Pull the lever and apply weight to or remove weight from the backrest as required



# Manual seat adjustment

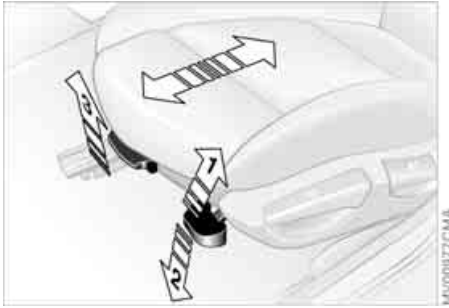

## BMW sports seat\* adjustment

You can also adjust the tilt angle and the thigh support:

- 1 To tilt up:  
Pull the lever up repeatedly, continuing until the seat reaches the desired tilt angle
- 2 To tilt down:  
Push the lever down repeatedly, continuing until the seat reaches the desired tilt angle
- 3 Thigh support:  
Pull the lever and adjust the position of the thigh support for your personal comfort

## 50 Power seat adjustment\*

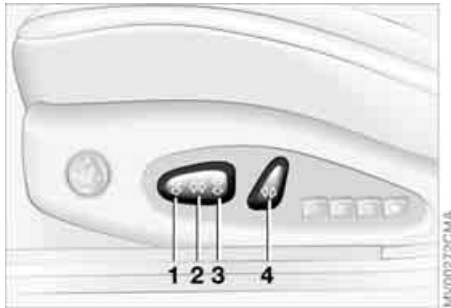

### Seat adjustment

- 1 Tilt angle
- 2 Backward/Forward adjustment
- 3 Height
- 4 Backrest angle

The head restraint is adjusted manually, refer to page 51.

With the BMW sports seat you can also adjust the thigh support, refer to page 49.



Please refer to the adjustment instructions on page 48 to reduce the risk of personal injury. ◀

## Lumbar support\*



### To adjust

You can adjust the backrest's contour for additional support in the curvature of your spine's lumbar region.

The upper hips and spinal column receive supplementary support to help you maintain a relaxed, upright posture.

- ▷ Press front/rear of switch: increase/decrease curvature
- ▷ Press the upper/lower end of the switch: increase the upper/lower curvature.

## Head restraints

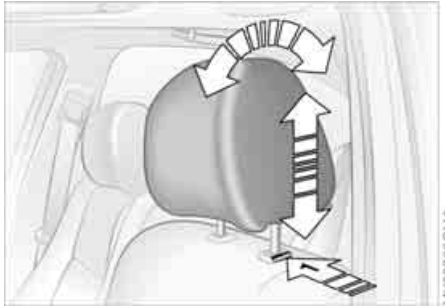

2. Press button – see arrow 1 – and remove the head restraint.

### Installation – front

Slide the head restraint into the sockets.

### To adjust

Height: pull the head restraint up or push it down.



Press button to retract to the lowest position – see arrow 1. ◀

Adjust the angle of the front head restraints by tilting them manually.



You can reduce the risk of spinal injury and whiplash by adjusting the head restraint to a height at which it is centered roughly at ear level. ◀

### Removal – front

1. Pull up the head restraint, continuing until it is at maximum extension

## Safety belts



### Always wear your safety belt

Always fasten your safety belt before starting off. As supplemental restraint devices, the airbags are designed to enhance the effectiveness of the safety belts, and not to replace them.

### To close

Make sure you hear the catch engage in the belt buckle.

### To release

1. Press red button in the belt buckle
2. Hold end of the belt
3. Guide belt back into the inertia reel.

## 52 Safety belts

▷ The rear belt buckle with the word CENTER is intended exclusively for the passenger sitting in the middle. ◀

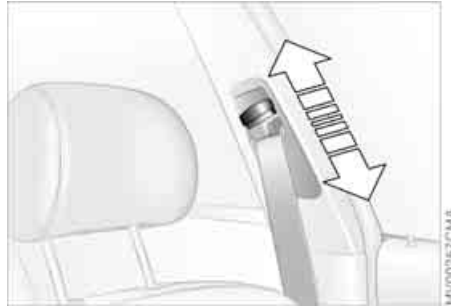

### Adjusting safety belt height

Use the height adjustment mechanism to adapt the shoulder strap to the ideal level for your own body:

▷ Slide the button up or down.

Please refer to the seat adjustment instructions on page 47.

**⚠** If the safety belt system has been subjected to the stresses involved in an accident or otherwise damaged: have the entire safety belt mechanism replaced by your BMW center, including the safety belt tensioner. In addition, have your BMW center inspect the safety belt anchors. If a child-restraint system was in the vehicle during an accident, consult the manufacturer's instructions regarding replacement. ◀

## Seat and mirror memory\*

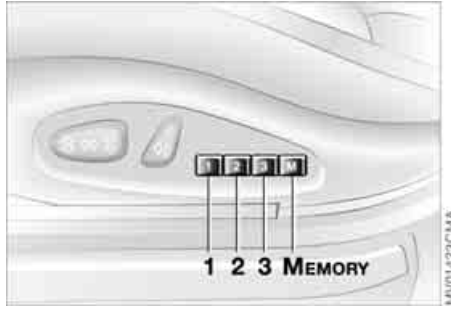

You can store and recall three different driver's seat and exterior mirror positions.

 Memory will not retain the adjustment made to the lumbar support. ◀

### To store

1. Ignition key position 1 or 2
2. Adjust your seat and exterior mirrors to the desired position
3. Press the MEMORY button: the indicator lamp in the button lights up
4. Press memory button 1, 2 or 3, as desired: indicator lamp goes out.

### To select a stored setting

 Do not select a memory position while the vehicle is moving. If you do so, there is a risk of accident from unexpected seat movement. ◀

Ignition key in position 1:

- ▷ Briefly press memory button 1, 2 or 3, as desired.  
Movement stops immediately when one of the seat-adjustment or memory buttons is activated during the adjustment process.

The driver's door is closed and the ignition key is either removed or in position 0 or 2:

- ▷ Maintain pressure on the desired memory button – 1, 2 or 3 – until the adjustment process is completed.

If you press the MEMORY button accidentally: press the button again; the indicator lamp goes out.

 Your BMW center can adjust your vehicle's systems in such a manner that your personalized settings are automatically set for the seat and exterior mirror positions when you unlock the vehicle with your personal remote control. ◀

 Before activating the programmed adjustment feature, ensure that the footwell behind the driver's seat is empty and unobstructed. If you fail to do so, persons, animals or objects could be injured or damaged if the seat should move backward. ◀

## 54 Seat and mirror memory\*



### Passenger-side exterior mirror tilt function

Automatic curb monitor\*

1. Move mirror selector switch 1 to the driver's mirror position
2. When shifting into Reverse or placing the selector lever in position R, the passenger-side mirror tilts downward to help the driver monitor the area directly adjacent to the vehicle during parking – curbs, etc.



How far the passenger mirror tilts can be set individually for each ignition key. ◀

You can deactivate this automatic feature by setting the mirror selection switch to the passenger side position.

## Seat heating\*

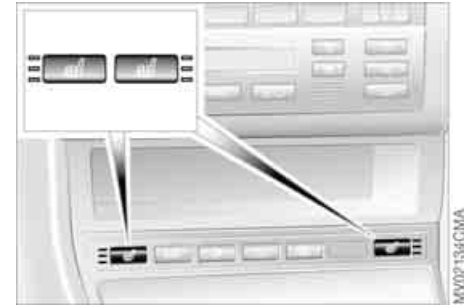

The seat cushion and backrest can be heated with the ignition key in position 2.

You can select different heating modes by repeatedly pressing the buttons.

You can also switch the higher heating modes off directly:

Press the button and hold it slightly longer.

## Steering wheel

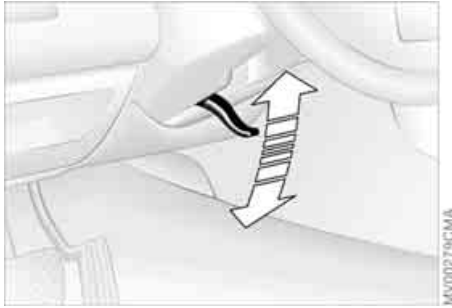

### To adjust

**!** Never attempt to adjust the steering wheel while driving the vehicle – it could respond with unexpected movement, posing a potential accident hazard. ◀

1. Push the locking lever downward
2. Adjust steering column reach and height for your selected seating position
3. Pull the lever back up to clamp the steering wheel in the new position.

## Mirrors

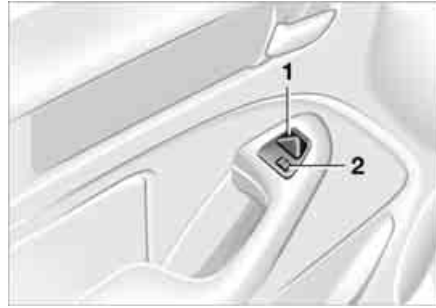

### To adjust exterior mirrors

- 1 Mirror switch for 4-way adjustment
- 2 Selection switch for changing between mirrors

### To adjust manually

The mirrors can also be adjusted manually:

Press against the edges of the lens.

For storing mirror settings, refer to Seat and mirror memory on page 53.

**!** The mirror on the passenger's side is convex. When estimating the distance between yourself and other traffic, bear in mind that the objects reflected in the mirror are closer than they appear. This means that estimates of the distance to following traffic should not be regarded as precise. ◀

### Electric defrosting\*

Both mirrors are automatically heated when you turn the ignition key to position 2.



### **Interior rearview mirror**

To reduce glare from vehicles behind you when you are driving at night, tilt the lens by turning the button.

Vehicles without alarm system:

Tilt the small lever forward.



### **Interior rearview mirror with automatic dimming feature\***

This mirror automatically responds to ambient light and headlamp glare from following vehicles by dimming through an infinitely variable range and automatically reverts to its clear, undimmed setting whenever you shift into Reverse or move the selector lever into position R.

To ensure that the mirror continues to operate efficiently, ensure that the photocells remain clear and unobstructed. One photocell is integrated in the mirror's lens – see arrow – while the other is located at an offset position on the

rear of the mirror. Refrain from attaching stickers or other objects to the windshield in the area immediately behind the rearview mirror.



# Airbags

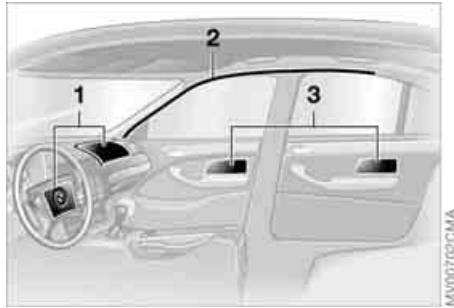

- 1 Front airbags on the driver and passenger sides
- 2 Head airbags for driver and front passenger
- 3 Side airbags on the driver and passenger sides – front and rear\*

## Protective effect

The front airbags supplement the three-point safety belts by providing additional protection in the event of a severe frontal collision in which the protection afforded by the belts alone may no longer be sufficient. The head and side airbags help provide protection in the event of a collision from the side. The respective side airbag helps support the seat occupant's upper body.

For information on the correct sitting posture, refer to page 47.

- ▶ The side airbags in the rear passenger area\* of your vehicle may already have been deactivated by a BMW center. You may have them activated if you desire to do so. Please contact your BMW center for additional information. ◀
- ▶ The airbags do not deploy in response to minor collisions, rear impacts and certain kinds of vehicle rollover. ◀



Do not apply adhesive materials to the cover panels of the airbags, cover them or modify them in any other way. Do not remove the airbag restraint system. In the event of a malfunction, deactivation or triggered activation – as a response to an accident – of the airbag restraint system, consult your BMW center for inspection, repairs or disassembly. Do not modify or tamper with either the wiring or the individual components in the airbag system. These include the upholstered covers on the steering wheel, the instrument panel, side panels on doors and the roof struts as well as down the sides of the roof liners. Also, do not attempt to remove the steering wheel. Unprofessional attempts to service the system could lead to failure in an emergency or undesired airbag activation, either of which could result in personal injury. Do not touch the individual components immediately after the system has been activated, as this could result in personal injury. ◀

 All vehicle occupants should always sit upright and be properly restrained – infants and small children in appropriate child-restraint systems; larger children and adults using the safety belts. Never let an occupant's head rest near or on a side airbag because the inflating airbag could cause a serious or fatal injury. Please note that the word Airbag imprinted on the door trim panel indicates the airbag's location.

Accident research shows that the safest place for children in an automobile is in the rear seat. However, a child sitting in the rear seat and not properly restrained could place his or her head on or near the airbag, if so equipped. For example, a child – even though belted in – may fall asleep with his or her head against the side airbag. It may be difficult for a driver to ensure that children in the rear seat will remain properly positioned at all times and not place their heads on or near the side airbag. Therefore, we recommend that the rear seat side airbags, if installed in the vehicle, be deactivated if children will travel in the rear seat.

The rear seat side airbags may already have been deactivated by a BMW center. If you are uncertain of their status,

or wish to have the airbags activated or deactivated, please contact your BMW center. ◀

Even when all these guidelines are followed, there is still a small residual risk of injuries to the face, hands and arms occurring from airbag deployment in isolated instances.

In sensitive individuals, the ignition and inflation noise may induce a mild hearing loss that is temporary in most cases.

Corresponding airbag warning labels are found on both sun visors.



This is the right way a child should sit in a child-restraint when rear side airbags are provided.

# Airbags



If there is a system malfunction, there is a risk that the airbags will not be triggered within their normal response range, even if the level of impact would normally have triggered them.

Have your BMW center inspect the airbag system immediately.

This is the right way a larger child should sit wearing the seat belt when rear side airbags are provided.

## Indicator lamp



The indicator lamp indicates the operational status of the airbag system when the ignition key is in position 1 or higher.

System operational:

- ▷ The indicator lamp comes on briefly when you turn the ignition key to position 1 or higher.

System malfunction:

- ▷ Indicator lamp does not come on or
- ▷ indicator lamp lights up continuously.

## 60 Transporting children safely

Commercially available child-restraint systems are designed to be secured with a lap belt or with the lap belt portion of a combination lap/shoulder belt. Improperly or inadequately installed restraint systems can increase the risk of injury to children. Always read and follow the instructions that come with the system.

### Correct location for installing

In your BMW, all seats equipped with a three-point safety belt – except for the driver's seat – are suitable for installing universal child-restraint systems of all age classes and which have been approved for the age group in question.

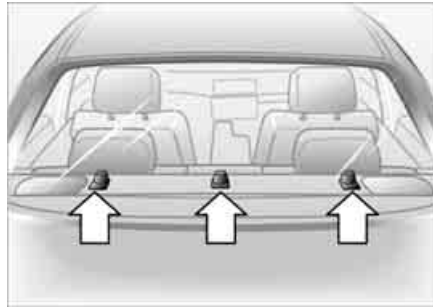

### Child-restraint system with tether strap

If you use a child-restraint system with a tether strap, three additional tether anchorage points have been provided.

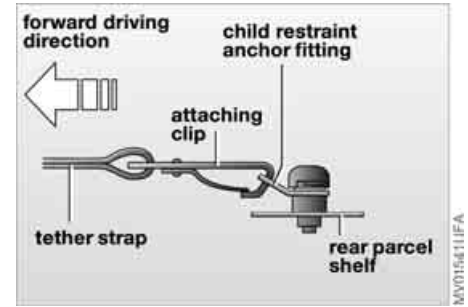

Depending on the location selected for seating in the rear passenger area, attach the tether strap to the corresponding anchorage point to secure the child-restraint system, as shown in the illustration.

If the respective seating position is fitted with a head restraint, lift the head restraint and pass the tether strap between the head restraint and the seat back.

It is recommended to readjust the head restraint in the lowest possible position.

Adjust the tether strap according to the child-restraint manufacturer's instructions.

## Transporting children safely



Before installing any child-restraint device or child seat, please read the following: Never install a rearward-facing child-restraint system in the front passenger seat of this vehicle.

Your vehicle is equipped with an airbag supplemental restraint system for the front passenger. Because the backrest on any rearward-facing child-restraint system – of the kind designed for infants under 1 year and 20 lbs/9 kg – would be within the airbag's deployment range, you should never mount such a device in the front passenger seat, since the impact of the airbag against the child-restraint's backrest could lead to serious or fatal injuries. If it is necessary for a child – not an infant – to ride in the front seat, certain precautions should be taken. First, move the passenger seat as far away from the dashboard as possible. This important precaution is intended to maximize the distance between the airbag and the child. Older children should be tightly secured with a safety belt after they have outgrown a booster seat that is appropriate for their age, height, and weight. Younger children should be secured in an appropriate forward-facing child-restraint system

that has first been properly installed with a safety belt.

Never install a rearward-facing child-restraint system in the front passenger seat.

We strongly urge you to carefully read and comply with the instructions for installation and use provided by the child-restraint's manufacturer whenever you use such a device.

Do not attempt to modify child-restraint systems. If you do this, the protection provided by these systems could be impaired.

Always ensure that all occupants – of all ages – remain properly and securely restrained at all times. ◀

All rear seating positions in your vehicle meet the recommendations of SAE J1819, an industry-recommended practice for securing child-restraint systems in motor vehicles.



### Securing child-restraint system

All of the rear belt retractors and the front passenger's safety belt can be locked for mounting and securing child-restraint systems.

A label with the appropriate instructions for this is located in the immediate vicinity of the buckle latch of each safety belt.

### To lock the safety belt

Extract the entire length of the belt from the inertia reel mechanism. Allow the reel to retract the belt somewhat and engage the buckle, then tighten the belt against the child-restraint system. The retraction mechanism is now locked.

## 62 Transporting children safely

The belt cannot be extracted further. Always observe the installation instructions provided by the manufacturer of the child-restraint system.

### To unlock the safety belt

Release the safety belt, remove the child seat and retract the safety belt to its end position on the belt retractor.

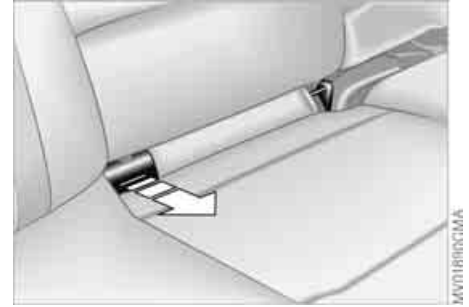
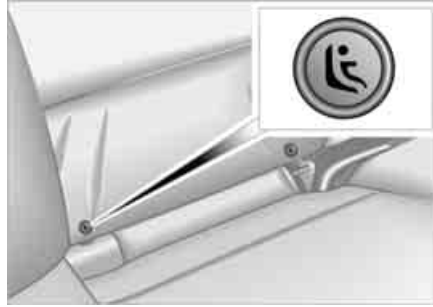

### LATCH child-restraint mounting system

LATCH: Lower Anchors and Tethers for CHildren

The left and right rear seats are both equipped with a LATCH child-restraint mounting system.

Canadian models only:

The LATCH anchorage points are identified by buttons.

Remove the cover from the outside mount by pulling forward. When re-installing ensure that the recess is on the top.



With through-loading system: tilt the backrest halfway forward to make the cover easier to remove, refer to page 112.

The illustration is an example showing the anchorages for a LATCH child-restraint mounting system at the right rear seat.



Always follow all manufacturer's instructions and observe all safety precautions when installing the LATCH child-restraint mounting system. ◀

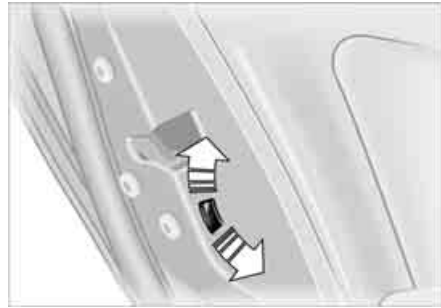

## Child safety locks

Slide down the lever located in the rear door:

The door can now be opened from the outside only.

**How the system functions**

No doubt you have reflected at one time or another on how great it would be if you could permanently configure your vehicle's various features and adjustments to mirror your own individual preferences. In engineering your vehicle, BMW has provided for a number of options for personal adjustment that can be programmed into your vehicle at your BMW center.

The available configuration data fall into two categories, according to whether their primary orientation is the vehicle – Vehicle Memory – or the individual – Key Memory. Provided that each person has a separate remote-control key, you can have your BMW center enter basic adjustment data for up to four individuals in the system.

The system then relies on a bilateral data exchange to identify the individual user and executes the selected settings whenever the remote control unit is used to disengage the door locks.

**Distinguishing between keys**

Color-coded decals have been provided to help you distinguish individual keys with different settings.

**What the system can do**

You can learn about the entire array of features this system offers at your BMW center.



You will see this symbol throughout the Owner's Manual. It is to remind you at appropriate places of the settings that are available to you. ◀

Examples for Vehicle Memory:

- ▷ Various signals as acknowledgment when locking or unlocking your vehicle, refer to pages 33, 36

- ▷ Activating/deactivating the 'Follow me home' function, refer to page 94
- ▷ Activating/deactivating daytime driving lamps, refer to page 94
- ▷ Selecting units of measure for displaying time, outside temperature, distance traveled and fuel consumption in the instrument panel
- ▷ When you shift into Reverse, an acoustic signal indicates that PDC has been activated, refer to page 86
- ▷ Switching on the rear window defroster automatically, refer to pages 100, 105
- ▷ Activates/deactivates various alarm system functions, refer to page 42
- ▷ Having the onboard computer display – after giving an ice warning – return to its previous setting, refer to page 84.

Examples for Key Memory:

- ▷ Unlocking the driver's door first, then the vehicle's remaining locks, refer to page 33
- ▷ Locking the vehicle after pulling away, refer to page 37
- ▷ Automatically repositioning of the driver's seat for the corresponding driver when the vehicle is unlocked, refer to page 53
- ▷ Automatic tilting of the passenger-side mirror, refer to Automatic curb monitor, page 54.



## Ignition lock

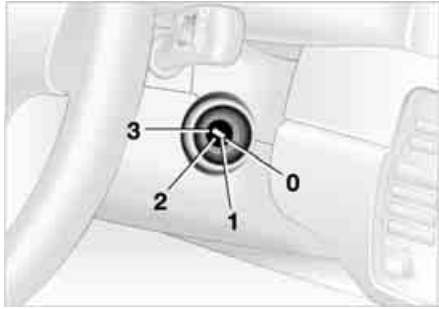

### Ignition key positions

- 0 Steering locked
- 1 Steering unlocked
- 2 Ignition switched on
- 3 Starting engine

 Vehicles with automatic transmission:

Do not move the selector lever from position P until the engine is running, ignition key position 2.

Your vehicle is equipped with an interlock. Therefore, the ignition key cannot be turned to position 0 or removed until the selector lever is in position P. ◀

 Vehicles with manual transmission:

Step on the clutch when starting the vehicle. A lockout prevents the engine from starting if the clutch is not depressed. ◀

### Steering locked

The key can only be inserted and removed in this position.

After removing the key, turn the steering wheel slightly to the left or right until the lock engages.

If the key is not removed, an acoustic signal is sounded after the driver's door has been opened.

### Steering unlocked

You will find that it is often easier to turn the ignition key from position 0 to position 1 when you move the steering wheel slightly to help disengage the lock.

Individual electrical accessories are ready for operation.

## Starting the engine

 Do not allow the engine to warm up by leaving it running while the vehicle remains stationary. Instead, drive off immediately at a moderate engine speed. ◀

 Do not allow the engine to run in enclosed spaces. Otherwise, breathing the exhaust fumes can lead to unconsciousness and death. The exhaust gases contain carbon monoxide, an odorless and colorless, but highly toxic gas. Do not leave the vehicle unattended with the engine running. An unattended vehicle with a running engine represents a safety hazard. When driving, standing at idle or parking the vehicle, take care to avoid contact between the hot exhaust system and flammable materials – grass, hay, leaves, etc. Such contact could lead to a fire, resulting in serious personal injury and property damage. ◀

Start the engine. Do not press the accelerator pedal.

 Do not actuate the starter for too short a time, but do not actuate it for more than approx. 20 seconds. Release the ignition key immediately when the engine starts. ◀

If the engine does not start on the first attempt – if it is very hot or cold, for instance:

- ▷ Press the accelerator pedal halfway down while engaging the starter.

Cold starts at extremely low temperatures below approx. +5 °F/-15 °C and at altitudes over 3,300 ft/1,000 m:

- ▷ On the first start attempt, it may be necessary to engage the starter for a longer period, but no longer than 20 seconds
- ▷ Press the accelerator pedal halfway down while engaging the starter.

 Extended starting attempts, characterized by excessively frequent or long periods with the starter engaged, can damage the catalytic converter. ◀

Engine idle speed is controlled by the engine computer system. Increased speeds at start-up are normal and should decrease as the engine warms up. If engine speed does not decrease, service is required.

To prevent the battery from discharging, always deactivate electrical devices that are not in use. Switch the ignition off when the vehicle is not being driven.

### **Manual transmission**

1. Engage the parking brake
2. Gearshift lever in idling position
3. Start the engine.

### **Automatic transmission**

1. Depress footbrake
2. Place the selector lever in position P or N
3. Start the engine.

 To prevent the vehicle from starting off on its own, always move the selector lever to position P and engage the parking brake before leaving your vehicle with the engine running.

Do not leave the vehicle unattended with the engine running. An unattended vehicle with a running engine represents a safety hazard. ◀

### **Sequential manual gearbox SMG**

1. Depress footbrake

2. Place the selector lever in neutral position N
3. Start the engine.

 If the engine does not start, reengage the gear last selected, refer to the gear indicator in the display, and move the selector lever into neutral position N again.

The gearbox is automatically taken out of gear if the driver's door is opened while the engine is running and the driver does not actuate the pedals, the shift paddles or the selector lever. This is accompanied by a warning tone and the flashing gear indicator. The gear display N appears in the instrument-cluster. ◀

 Before exiting the vehicle with the engine running, move the selector lever into position N and apply the parking brake.

Do not leave the vehicle unattended with the engine running. An unattended vehicle with a running engine represents a safety hazard. ◀

## Switching off the engine

 You should never remove the ignition key when the vehicle is in motion, as the steering lock could engage.

When you leave the vehicle, always remove the ignition key and engage the steering lock.

Always engage the parking brake when parking on downhill roads. Engaging a gear may not sufficiently secure the vehicle against rolling. ◀

### Manual transmission

Turn the ignition key to position 1 or 0.

### Automatic transmission

Move the selector lever into position P, and turn the ignition key to position 1 or 0.

### SMG gearbox

If you turn the ignition key to position 1 or 0 with the selector lever in position R, or in sequential mode, a gear automatically remains engaged.

If you turn the ignition key to position 1 or 0 with the selector lever in neutral position N, a warning tone and the flashing gear indicator in the display remind you that no gear is engaged to secure the vehicle against rolling.

The warning stops after approx. 9 seconds.

## Parking brake

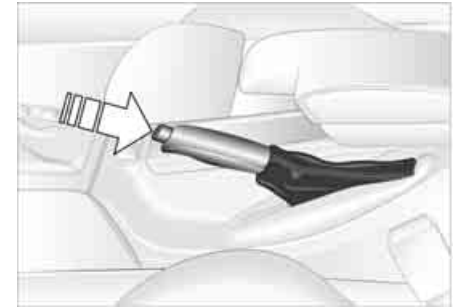

The parking brake is designed primarily to prevent the vehicle from rolling when it is parked. It operates against the rear wheels.

### To engage

The detent engages automatically, and the indicator lamp in the instrument cluster comes on when the ignition key is in position 2, refer to page 18.

### To release

Pull up slightly on the lever, press the button and lower the lever.

 If exceptional circumstances make it necessary to engage the parking brake while the vehicle is in motion, do not pull it with excessive pressure. Keep your thumb pressed against the release button while carefully pulling the lever up.

Excessive pressure can lead to over-braking and loss of traction – fishtailing – at the rear axle. The brake lamps do not come on when the parking brake is engaged.

Vehicles with manual or SMG gearbox: Engage the parking brake when parking on downhill roads, since engaging a gear may not provide adequate resistance to rolling, not even in first or reverse gear.

Vehicles with automatic transmission: place the selector lever in P. ◀

 To avoid corrosion and one-sided braking, apply the parking brake lightly from time to time when coasting to a standstill – at a traffic signal, for example – provided that it is safe to do so. ◀

## Manual transmission

 Do not hold the vehicle in place on slopes by slipping or 'riding' the clutch. Use the parking brake instead. Riding the clutch leads to severe and premature clutch wear. ◀

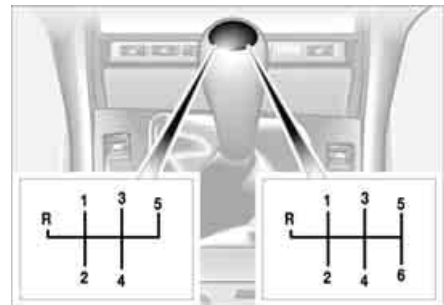

### 6-speed transmission\*

When changing gear in the 5th/6th gear plane, be sure to press the gearshift lever to the right to prevent inadvertently shifting to a gear of the 3rd/4th gear plane.

### Reverse

Select only when the vehicle is stationary. Press the shift lever to the left to overcome the resistance.

As you do this, the backup lamps will light up automatically when the ignition key is in position 2.

# Sequential manual gearbox SMG\*

## The concept

The sequential manual gearbox SMG is an automated manual gearbox with which clutching and shifting is assumed by an electro-hydraulic system.

The SMG is operated via the selector lever in the center console and two shift paddles on the steering wheel.

It offers the following functions:

- ▷ Sequential mode: manual mode
- ▷ Drive mode: automatic operation
- ▷ Ability to choose between two different driving programs: Standard, Sport
- ▷ Operating safety through protection against misshifting
- ▷ Automatic upshifts and downshifts in the drive mode
- ▷ Automatic downshifts at minimum engine rpm
- ▷ Kickdown function in the drive mode.
- ▷ Acceleration assistant, refer to page 72.



## Selector lever positions

The current selector lever position is indicated by a light-emitting diode in the center console.

R: Reverse

N: Neutral

Position for forward driving with one-touch functions:

Sequential mode

+ : manual upshifts

- : manual downshifts

D: drive mode.

The SMG is ready for operation in ignition key position 2.

▶ The gearbox is automatically placed in neutral gear if the driver's door is opened while the engine is running and the driver does not actuate the pedals, the shift paddles or the selector lever.

This is accompanied by an acoustic signal and the flashing gear indicator. The gear display N appears in the instrument cluster.

A driving position can only be engaged when the driver's door is closed. When the vehicle is unlocked, a buzzer in the area of the transmission indicates that the system is ready for operation. ◀

## Shiftlock

When the car is at a standstill, a safety function requires you to depress the brake pedal if you want to move the selector lever from the neutral position N to a driving position.

## Driving precautions

⚠ Use enough acceleration to pull away speedily when moving off on an uphill gradient. Never try to prevent the car from rolling back on an uphill gradient by depressing the accelerator pedal; always apply the handbrake. Otherwise you could overheat the SMG gearbox. ◀

## 70 Sequential manual gearbox SMG\*

### R Reverse

Select only when the vehicle is stationary.

### N Neutral

Always engage before starting the engine, refer to Starting the engine on page 66.

### Sequential mode

Each time the engine is started, the sequential mode is activated as soon as you move the selector lever into the forward driving position while the brake is depressed.

The gears are shifted via the shift paddles or the selector lever.

It is also possible to drive off in second gear, e.g. on snow-covered roads.

### D Drive mode

In the drive mode all forward gears are shifted automatically.

To switch from sequential to drive mode: tap the selector lever to the right toward D.

For rapid acceleration, e.g. during passing, depress the accelerator pedal completely: kickdown.

To switch back to sequential mode: tap the selector lever again to the right toward D or change the current gear via the shift paddles or the selector lever.

### Kickdown

You can achieve maximum acceleration using kickdown.

Depress the accelerator pedal past the increased resistance point at the full-throttle position.



### Shifting gears

With selector lever:

- ▷ To upshift, tap the selector lever toward +
- ▷ To downshift, tap the lever toward –.

With shift paddles on steering wheel:

- ▷ To upshift, pull one of the shift paddles
- ▷ To downshift, push the paddle.

You accelerate from higher gears, e.g. during passing, by manually downshifting.

In the following situations, the SMG in the sequential mode assists you:

- ▷ The transmission will only execute upshifts and downshifts that will result in an appropriate combination of vehicle speed and engine rpm. For

## Sequential manual gearbox SMG\*

instance, downshifts that would result in excessive engine speed cannot be executed

- ▷ When you brake the car to a stop, the transmission automatically shifts down to first gear
- ▷ As speed diminishes the transmission will shift down automatically, without any action on your part, just before the vehicle slows to below each gear's minimum speed.



For information on jump-starting and towing the vehicle, refer to page 153.

### Warning tone

An acoustic signal sounds if the SMG gearbox overheats; if possible you should either stop or increase your pull-away speed so that the system can cool down.

### Available displays

R N 1 2 3 4 5 6

D1 D2 D3 D4 D5 D6

The currently engaged gear, the selected mode, and any malfunctions are displayed in the instrument cluster.

### Indicator lamp



If the indicator lamp comes on, there is a malfunction in the transmission system.

All selector lever positions can still be engaged, but in the forward driving positions only certain gears are actually available when the vehicle is driven.

Avoid extreme loads and proceed to the nearest BMW center.

## 72 Sequential manual gearbox SMG\*



1. Activate the Sport program
2. Press and hold the DSC button, refer to page 87, for more than three seconds
3. Quickly press the accelerator pedal down fully: kickdown. The optimum rpm for driving off will be adjusted.

 To maintain vehicle stability, always drive with the DSC activated whenever possible. ◀

### Sport program

You can choose between two driving programs: smoothly dynamic or Sport. With the Sport program, gearshifts are faster in sequential mode and the shift points are adapted in drive mode.

To activate the Sport program: press the SPORT button. The LED in the button lights up.

### Acceleration assistant

The acceleration assistant permits optimum racing-style acceleration on roads with good grip.

 Do not use the acceleration assistant frequently as this could otherwise cause premature wear of the components. ◀



# Automatic transmission with Steptronic\*

You can drive as with a normal automatic transmission. In addition, you can also shift manually.

When you move the selector lever from the D position to the left into the M/S range, the performance-oriented shift programs of the automatic transmission are engaged. Steptronic enters the manual selection mode and executes the desired shift whenever you tap the selector lever in the direction indicated by + or -. Whenever you want to use automatic again, just move the selector lever toward the right to position D.

Under normal operating conditions, fuel consumption is lowest when driving in position D.

## Selector lever positions

P R N D M/S + -

## Starting the engine

The engine can only be started in selector lever positions P – for Park – or N – for Neutral.



## Range selection

A catch prevents inadvertent movement of the selector lever to positions R and P. To deactivate the catch, press the button on the front of the selector lever knob, see arrow.

 While the vehicle is stationary and before shifting out of Park or Neutral, depress the footbrake in order to disengage the selector lever's lock mechanism – Shiftlock. ◀



Hold the footbrake down until starting off. The vehicle will otherwise 'creep' when a drive position is engaged. To prevent the vehicle from starting off on its own, always move the selector lever to position P and engage the parking brake before leaving your vehicle with the engine running. Do not leave the vehicle unattended with the engine running. An unattended vehicle with a running engine represents a safety hazard. ◀

## P Park

Select only when the vehicle is stationary. Transmission locks to prevent rear wheels from turning.

## R Reverse

Select only when the vehicle is stationary.

## N Neutral

Select only when stopping for an extended period.

## D Drive – automatic shift program

This position is designed for driving under all normal operating conditions. All forward gears are available.

### **Kickdown**

In the kickdown mode, you achieve maximum acceleration and top speed in position D.

Depress the accelerator pedal past the increased resistance point at the full-throttle position.



### **M/S manual operation and Sport program**

Move the selector lever from D to M/S to activate the Sport program; SD appears in the display panel. The M/S mode is recommended for performance-oriented driving.

Once in the M/S mode, you can tap the selector lever to switch the automatic transmission from the Sport program to its manual mode.

This mode allows you to execute upshifts manually by tapping the lever toward +, while downshifts are selected by tapping in the – direction. The displays M1 through M5 appear in the display panel to indicate your current gear selection.

The transmission will only execute upshifts and downshifts that will result in an appropriate combination of vehicle speed and engine rpm. For instance, downshifts that would result in excessive engine speed are not executed. The desired, then the actual gear, briefly appear in the instrument cluster.

 To accelerate quickly in the manual mode for maneuvers such as passing another vehicle, shift down manually or employ the kickdown mode. ◀

Shifting from M/S to the selector lever positions P, R and N is possible only by going through D.

## Automatic transmission with Steptronic\*



If the indicator lamp does not go out, you can place the selector lever in all positions. However, the vehicle will now only operate in 3rd and 4th gear.

If this happens, avoid extreme engine loads and consult the nearest authorized BMW center.

 Never work in the engine compartment when a drive gear – forward or reverse – is engaged. If you do this, the vehicle could move. ◀

For towing or jump-starting, refer to the information beginning on page [153](#).

### Available displays

P R N D SD M1 M2 M3 M4 M5

### Electronic transmission control module



If the indicator lamp comes on, there is a malfunction in the transmission system.

Bring the vehicle to a stop. Move the transmission selector lever to P. Set the parking brake and turn the engine off – ignition key to position 0.

Wait a few seconds, then start the engine.

If the indicator lamp goes out after a few seconds, normal transmission performance has been restored. You may continue to drive as usual.

## 76 Turn signal indicator/Headlamp flasher

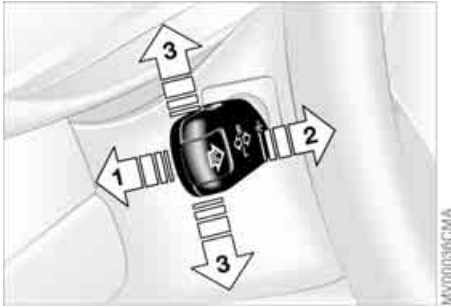

- 1 High beams – blue indicator lamp
- 2 Headlamp flasher – blue indicator lamp
- 3 Turn signal indicator – green indicator lamps accompanied by a periodic clicking sound from the relay

### To signal briefly

Press the lever up to but not beyond the resistance point. It then returns to the center position when released.

 If the flashing of the turn signal indicators and the clicking from the relay are both faster than normal, one of the turn signal indicators has failed. ◀



- 0 Wipers retracted
- 1 Intermittent operation or rain sensor
- 2 Normal wiper speed
- 3 Fast wiper speed
- 4 Brief wipe
- 5 Rotary dial for control of the wipe interval or the sensitivity of the rain sensor

## Intermittent mode

Not on vehicles with rain sensor.

You can set the wipe interval at four stages with rotary dial 5.

In addition, the wipe interval is varied automatically depending on road speed.

## Rain sensor

The rain sensor is positioned on the windshield, directly behind the interior rearview mirror.

To activate the rain sensor:

- ▷ With the ignition key in position 1 or higher, move the lever to position 1. The wipers will make at least one sweep across the windshield. You can leave the lever permanently in position 1. With the ignition key in position 1 or higher, all you then need to do to activate the rain sensor is
  - ▷ briefly turn the rotary dial 5, or
  - ▷ clean windshield 1, refer to page 78.

To adjust the sensitivity of the rain sensor: turn rotary dial 5.

To deactivate the rain sensor:

Put lever in position 0.



Turn the rain sensor off in automatic car washes. Failure to do so could result in damage caused by undesired wiper activation. ◀

## Normal wiper speed

When the vehicle is stationary, the wipers switch automatically to intermittent wipe – not on vehicles with rain sensor.

## Fast wiper speed

When the vehicle is stationary, the wipers operate at normal speed – not on vehicles with rain sensor.



### **Cleaning windshield and headlamps\***

0 Wipers retracted

1 Clean windshield and headlamps\*

 Do not use the washers if there is any danger that the fluid will freeze on the windshield, as your vision could be obscured. Always use a windshield washer antifreeze in cold weather. Refer to page 132. Do not use the washers when the reservoir is empty. This could cause damage to the washer pump. ◀

The system sprays washer fluid against the windshield and activates the wipers for a brief period.

When the vehicle's lighting system is switched on, the headlamps will also be cleaned at reasonable intervals.

### **Windshield washer nozzles**

The windshield washer nozzles are heated automatically\* when the ignition key is in position 2.

## **Cruise control\***

Starting at about 20 mph / 30 km/h, you can maintain and store any vehicle speed that you specify.

The cruise control is operational whenever the engine is running and the system has been activated.

### **To activate the system**

1/0

In ignition key position 2: press the button in the steering wheel. The indicator lamp in the instrument cluster comes on, refer to page 20. You can now use the cruise control.

 Do not use cruise control on twisting roads, when high traffic density prevents driving at a constant speed, or when the road surface is slick – snow, rain, ice – or loose – rocks or gravel, sand. ◀

### **To deactivate the system**

1/0

Press button as often as you need to until the indicator lamp in the instrument cluster goes out.

Cruise control is also deactivated when the ignition key is in position 0.

## Cruise control\*

The speed stored in memory is deleted.

### To store and maintain speed or to accelerate



Press button + briefly:

The system stores and maintains the current vehicle speed. Every time you tap the button, the speed increases by approx. 0.6 mph / 1 km/h.

Press and hold button +:

The vehicle accelerates without pressure on the accelerator pedal. When you release the button, the system stores and maintains the current speed.



If on a downhill gradient the engine braking effect is not sufficient, the controlled speed can be exceeded. Speed can drop on uphill grades if the engine output is insufficient. ◀

### To decelerate



Press button – briefly:

When cruise control is active, every tap of the button reduces the speed by approx. 0.6 mph / 1 km/h.

Press and hold button –:

With the cruise control active, the system automatically reduces the throttle opening to slow the vehicle. When you release the button, the system stores and maintains the current speed.

### To interrupt the cruise control



When the system is activated, press the button. The indicator lamp stays on. You can use the cruise control again whenever you want by calling up the speed that was stored last.

In addition, cruise control is interrupted automatically:

- ▷ When the brakes are applied
- ▷ When you apply pressure to the clutch pedal, or when you move the automatic transmission selector lever from D to N
- ▷ If you exceed or fall below the programmed speed for an extended period – by depressing the accelerator, for example.

### To recall the stored setting



Press button:

The vehicle accelerates to and maintains the last speed stored.



- 1 Odometer
- 2 Trip odometer

### **Odometer**

You can activate the displays shown in the illustration with the ignition key in position 0 by pressing the left button in the instrument cluster.

### **Trip odometer**

To reset the trip odometer to zero, press the left button with the ignition key in position 1 or higher.



Do not operate the engine with the needle in the red overspeed zone of the gauge.

To protect the engine, the fuel supply is interrupted when you approach this sector.



Indicates the current fuel consumption in mpg – in liters/100 km on Canadian models. This allows you to see whether your current driving style is conducive to fuel economy with minimum exhaust emissions.

When the vehicle is stationary, the display goes to Maximum – zero on Canadian models.



## Fuel gauge



Once the indicator lamp stays on continuously, there are still approx. 2 gallons/8 liters of fuel in the fuel tank. Fuel tank capacity approx. 16.6 gallons/63 liters.

Certain operating conditions, such as those encountered in mountainous areas, may cause the needle to fluctuate slightly.



Fill the fuel tank before it is completely empty. Driving to the last drop of fuel can prevent the engine from operating properly and result in damage. ◀

When you switch on the ignition, the indicator lamp lights up briefly as an operation check.

## Engine coolant temperature gauge



### Blue

The engine is still cold. Drive at moderate engine and vehicle speeds.

### Between the blue and red zones

Normal operating range. The needle may rise as far as the edge of the red sector during normal operation.

### Red

When you switch on the ignition, the warning lamp comes on briefly as an operation check.

If the lamp comes on during normal vehicle operation: the engine has overheated. Shut off the engine immediately and allow it to cool down.

To check coolant level, refer to page [134](#).

## 82 Service interval display



A flashing message and a '-' in front of the number mean that the service interval has already been exceeded by the distance shown on the display. Please contact your BMW center for an appointment.

### Remaining distance to next service

The displays shown in the illustration appear for a few seconds when the ignition key is in position 1 or higher or after the engine is started.

The next service due appears with the message OIL SERVICE or INSPECTION, together with the distance remaining in miles – in kilometers in Canada – before the next scheduled service.

The computer bases its calculations of the remaining distance on the preceding driving style.

## Check Control

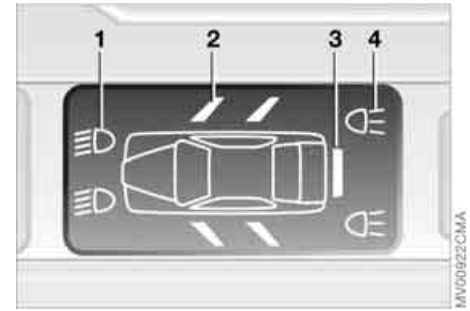

When the ignition key is in position 2, the following information and/or conditions are indicated using symbols until the conditions have been corrected.

- 1 Check the low beam and high beam headlamps, as well as the parking lamps
- 2 Door open
- 3 Luggage compartment lid open
- 4 Check brake and tail lamps

When you open the driver's door after having turned the ignition key to position 0, you will hear an acoustic signal for a few seconds to remind you that the lamps have not been switched off.

# Clock

If you wish to have a permanent time display, you can make this adjustment in the radio display, refer to the Owner's Manual for Radio.

You can adjust the clock and the time display in the car radio as follows.



Every time you press the button, the clock display alternates between the 12-hour and 24-hour mode.

In ignition key position 0: the time is displayed for a few seconds after you press the left button, refer to Odometer on page 80.

## Setting

 Before the clock can be set, the time must be showing in the instrument cluster display. ◀

With the ignition key in position 1 or higher

To set ahead: turn the right button to the right.

To set back: turn the right button to the left.

The adjustment speed will increase the longer you continue to hold the right button.

To change the display mode: press the right button briefly.



After giving an ice warning, the display returns to the previous setting. ◀



The ice warning does not alter the fact that surface ice can form at temperatures above 37.5 °F/+3 °C, on bridges or shaded road surfaces, for instance. ◀

### Mode selection

With the ignition key in position 1 or higher, you can use the button in the turn signal lever to request information from the computer. Each time you press the button briefly toward the steering column, a new function is called up in the display.

The displays appear in the following order:

Time of day, outside temperature, average fuel consumption, cruising range, average vehicle speed.

With the ignition key in position 1 or higher, the last active setting is displayed.

### Outside temperature

You can change the units of measure °C/°F for the outside temperature display by pressing the right-hand reset button in the instrument cluster while the temperature display is active. The units of measure °C/°F in the temperature display of the automatic climate control change automatically, see page 102.

### Ice warning

If the outside temperature drops to about 37.5 °F/+3 °C, then the computer will automatically switch to a display of the outside temperature. In addition, a signal sounds as a warning and the display flashes for a brief period.

# Computer\*



MV01044CMA

## Average fuel consumption

If you continue to press and hold the button on the turn signal lever, the average fuel consumption last displayed is recalculated from that point in time.



If you wish, you can have the average fuel consumption displayed in a different unit of measure. ◀

## Range

The computer bases its calculations for the cruising range on the operating conditions in the preceding period and on the remaining fuel in the tank.



It is important that you refuel when the cruising range falls below approx. 35 miles/50 km. Otherwise, the engine cannot be guaranteed to operate properly and damage may result. ◀

## Average speed

If you continue to press and hold the button, the average speed being displayed is recalculated from that point in time.

Any time spent when the vehicle is stationary and the engine is shut off is ignored for the calculation.

**The concept**

PDC assists you when you back into a parking space. Acoustic signals alert you to the momentary distance to an object behind your vehicle. The system features four ultrasonic sensors mounted in your rear bumper. The monitoring range for the two corner sensors extends outward roughly 2 ft/60 cm behind the bumpers, while two centrally located sensors detect objects at distances of up to approx. 5 ft/1.50 m.

 PDC is a parking aid that can identify objects if they are approached slowly, as is generally the case when parking. Avoid driving towards objects rapidly; due to underlying physical principles, the system may otherwise alert you too late for you to take evasive steps. ◀

The system starts to operate automatically approx. one second after you shift into Reverse or move the selector lever into the R position with the ignition key in position 2.

 Let this short period elapse before driving backwards. ◀

PDC is deactivated when you shift back out of Reverse.



You can have a signal set to confirm that the PDC has been activated. The signal then sounds when you shift into Reverse or move the selector lever into the R position. ◀

**Acoustic signals**

The distance to the nearest object is indicated by a tone sounding at various intervals. As the distance between vehicle and object decreases, the intervals between the tones become shorter. A continuous tone indicates the presence of an object less than 1 ft/30 cm away.

The warning signal is canceled after approx. three seconds if the distance to the object remains constant during this time – if you are moving parallel to a wall, for instance.

System malfunctions will be indicated by a continuous high-pitched tone when the system is activated the first time. Please have the problem fixed by your BMW center.



PDC does not remove the driver's personal responsibility for evaluating the distance between the vehicle and any objects. Even when sensors are involved, there is a blind spot in which objects cannot be detected. This applies especially in those cases where the system approaches the physical limits of ultrasonic measurement, as occurs with tow bars and trailer couplings, and in the vicinity of thin or wedge-shaped objects. Moreover, low objects that have already been detected – such as a curb edge – can disappear out of the detection range of the sensors before a continuous tone sounds.

Loud sources of sound from outside or inside the vehicle could drown out the PDC signal tone. ◀



Keep the sensors clean and free of ice or snow in order to ensure that they will continue to operate effectively.

Do not apply high pressure spray to the sensors for a prolonged period of time. Always maintain a distance of more than 4 in/10 cm. ◀

# Dynamic Stability Control (DSC)

## The concept

DSC maintains vehicle stability, even in critical driving situations.

The DSC is operational every time you start the engine.

DSC incorporates the Dynamic Traction Control (DTC) and Cornering Brake Control (CBC) functions.

For information on vehicles with all-wheel drive, refer to page 89 ff.

The vehicle will remain completely operational, however, without DSC. In the event of a fault, please consult your BMW center.



Indicator and warning lamps for Canadian models.



## Indicator lamps



The indicator lamp in the instrument cluster goes out shortly after the ignition has been switched on; refer to page 19.

- ▷ The indicator lamp flashes: DSC is actively controlling drive torque and braking intervention
- ▷ The indicator lamp stays lit: DSC has been switched off with the button; DTC and DBC are operational. DTC control intervention is not indicated.



The indicator lamp and the brake warning lamp continuously light up in yellow:

**BRAKE**

The DSC, DTC and DBC have been switched off manually or there is a system malfunction.



## Deactivating the DSC/activating the DTC

Press the DSC button briefly; the indicator lamp comes on and stays on.

DSC is deactivated; DTC is operational.

In the following rare situations, it may prove useful to activate the DTC for a brief period:

- ▷ When rocking the vehicle or starting off in deep snow or on loose surfaces
- ▷ When driving on snow-covered grades, in deep snow, or on a snow-covered surface that has been packed down from being driven on
- ▷ When driving with snow chains.

## 88 **Dynamic Stability Control (DSC)**

Under these special circumstances traction is increased by deactivating the control systems that enhance traction under normal conditions.

### **Deactivating the DSC and the DTC**

Press the DSC button down for at least 3 seconds; the indicator lamp and the yellow brake warning lamp will remain on continuously.

The systems for enhancing stability and traction are deactivated, and there is no active braking intervention or torque control.



To maintain vehicle stability, always drive with the DSC activated whenever possible. ◀

### **Reactivating the DSC**

Press the button again briefly; the indicator lamp or the indicator lamps will go out. DTC is deactivated.



The laws of physics cannot be repealed, even with DSC. An appropriate driving style always remains the responsibility of the driver. We therefore urge you to avoid using the additional safety margin of the system as an excuse for taking risks. Whenever the DTC is activated, the DSC is switched off and DTC performs minor stabilizing intervention. Do not make any modifications to the DSC system. Allow only authorized technicians to perform service procedures on the DSC. ◀



## The concept

DSC maintains vehicle stability, even in critical driving situations.

The DSC is operational every time you start the engine.

DSC includes the Automatic Differential Brake (ADB-X) and Cornering Brake Control (CBC) functions.

The vehicle will remain completely operational, however, without DSC. In the event of a fault, please consult your BMW center.

## Indicator lamps



The indicator lamp in the instrument cluster goes out shortly after the ignition has been switched on; refer to page 19.

- ▷ The indicator lamp flashes: DSC is actively controlling drive torque and braking intervention
- ▷ The indicator lamp stays lit: DSC has been switched off with the button; ADB-X is operational. ADB-X control intervention is not indicated.

▷ If the indicator lamp fails to go out when you press the DSC button, this indicates a malfunction in the DSC and ADB-X systems; the system is deactivated, and the stability enhancement functions are no longer available. ◀



## To deactivate DSC

Press the DSC button; the indicator lamp comes on and stays on.

DSC is now off, and ADB-X reverts to its maximum torque-transfer mode.

In the following exceptional circumstances, it may be effective to deactivate the DSC for a short period:

- ▷ When rocking the vehicle or starting off in deep snow or on loose surfaces
- ▷ When driving with snow chains.

▷ To maintain vehicle stability, always drive with the DSC activated whenever possible. ◀

### **Reactivating the DSC**

Press the button again; the indicator lamp goes out.



The laws of physics cannot be repealed, even with DSC. An appropriate driving style always remains the responsibility of the driver. We therefore urge you to avoid using the additional safety margin of the system as an excuse for taking risks. The system does not intervene to enhance vehicle stability when switched off. Do not make any modifications to the DSC system. Allow only authorized technicians to perform service procedures on the DSC. ◀

## Hill Descent Control (HDC)\*

### The concept

By reducing the vehicle's speed on steep downhill stretches, HDC maintains predictable vehicle handling response to provide you with control of your BMW during extreme descents.

The vehicle slows to a pace just slightly faster than walking speed.

HDC is available for activation at vehicle speeds below approx. 22 mph / 35 km/h. When driving down steep hills, the vehicle reduces speed automatically down to about double walking speed – approx. 7.5 mph / 12 km/h – and then maintains this speed at a constant.

You can use the accelerator or brakes to vary this speed within a range from approx. 3 mph / 5 km/h to approx. 15 mph / 25 km/h.

In conjunction with the multifunction steering wheel, you can use the +/- button to set the cruise control to a target speed in the range from approx. 3 mph / 5 km/h to approx. 15 mph / 25 km/h.

HDC is automatically deactivated once vehicle speed again exceeds approx. 37 mph / 60 km/h.



### To activate the system

Press the HDC button; the green indicator lamp integrated within the button comes on.

The indicator lamp flashes whenever the system is actively intervening to control your speed with automatic brake applications.

### To deactivate the system

Press the button again, the indicator lamp goes out.

HDC is automatically deactivated once the vehicle accelerates to more than 37 mph / 60 km/h, as well as whenever you switch off the ignition.

### To use HDC

Vehicles with manual transmission: You should always ensure that either reverse or first gear is engaged before using HDC, as the engine's braking effect is most pronounced in these gears, and only reduced engine braking is available in higher gears.

Vehicles with automatic transmission: HDC is available for use in all ranges.

### System malfunctions

Are signaled by the indicator lamp, which responds to problems by going out while HDC is in operation or by failing to come on when you activate the system:

HDC has been temporarily deactivated as a result of high brake temperatures.

 If the DSC indicator lamp comes on at the same time:

Malfunction in HDC and DSC system. Refer the problem to your BMW center.

**The concept**

As you drive, the Flat Tire Monitor keeps track of pressure levels in all four tires. The system alerts you whenever the inflation pressure of a tire falls significantly below the pressure of another tire.

The system actually detects pressure loss by monitoring differences in the relative speeds of the four wheels. It interprets variations outside specified limits as severe pressure loss, and then responds by generating a warning.

**Functional requirements**

In order for the Flat Tire Monitor to learn the correct tire inflation pressure, please do the following:

1. Check the tire inflation pressures in all tires
2. Compare them with the tire inflation pressure table on page 26 and correct them, if necessary
3. Initialize the system.

**System limitations**

 The Flat Tire Monitor cannot provide you with advance warning of sudden and severe tire damage caused by external factors and does not detect the balanced and very gradual pressure loss that takes place in all four tires over an extended period of time. ◀

On the other hand, the following situations can lead to a delayed detection of pressure loss and even to the system not functioning:

- ▷ Driving on snow-covered or slippery roads
- ▷ Performance-oriented driving: slip at the drive wheels, high levels of lateral acceleration
- ▷ When driving with snow chains, false warnings and undetected pressure losses may occur
- ▷ When driving with a space-saver spare tire, the Flat Tire Monitor cannot function.

**Initializing the system**

 Each time you correct the pressure in a tire, or change a wheel or tire, reinitialize the system immediately afterwards. This requires a bit of driving. ◀

1. Before driving off, start the engine but do not start driving
2. Press the button as long as you need until the yellow indicator lamp in the instrument cluster lights up for a few seconds
3. Drive off.

It takes a few minutes before the Flat Tire Monitor can detect a flat tire and issue a warning.

 When driving with snow chains or a space-saver spare tire, do not initialize the system. ◀

### Flat tire

 The indicator lamp in the instrument cluster lights up red. This visual alert is accompanied by an acoustic warning signal.

1. Carefully reduce speed and come to a stop. Avoid sudden braking and steering maneuvers
2. Determine which wheel is damaged

 If this cannot be determined, contact your BMW center. ◀

3. Replace the damaged wheel, refer to Changing a wheel on page 147.

After replacing the damaged tire, initialize the system.

Vehicles with Run Flat tires:

1. Carefully reduce your speed to under 50 mph / 80 km/h. Avoid strong braking and steering maneuvers. Do not exceed a speed of 50 mph / 80 km/h.

 Because the sides of Run Flat tires are reinforced, a drop in inflation pressure usually cannot be detected from the outside, refer to Run Flat tires, page 150. ◀

2. To continue driving, follow the instructions under Driving with a damaged tire on page 151.

### System malfunction

 The indicator lamp in the instrument cluster lights up yellow. The Flat Tire Monitor is malfunctioning or out of order. Please refer the problem to your BMW center.

The brake force display indicates to the driver of the vehicle behind you how hard you are braking your vehicle.

The display has two levels:

- ▷ Normal braking: the brake lamps among the rear lamps and the center brake lamp light up
- ▷ Hard braking or use of ABS: the tail lamps light up with the same brightness as the brake lamps and thereby intensify the visual effect of the brake lamps.

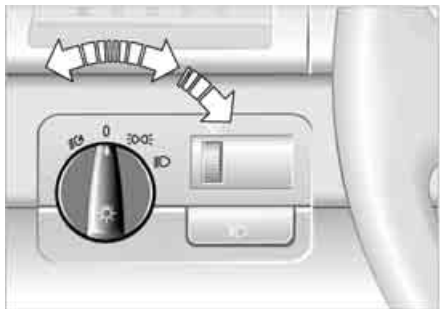

### **Parking lamps**

 The front, rear and side vehicle lighting is switched on. You can use the parking lamps to signal the position of the vehicle when it is parked. For lighting on one side for parking as an additional feature, refer to page 95.

### **Low beams**

 When the ignition is switched off while the low beams are on, the headlamps go out and only the parking lamps remain on.

### **Follow me home lamps**

When you activate the headlamp flasher after parking the vehicle with the lamps turned off, the low-beam headlamps will come on for a short time.



You can also have this function deactivated. ◀

### **LIGHTS ON warning**

When you open the driver's door after having turned the ignition key to position 0, you will hear an acoustic signal for a few seconds to remind you that the lamps have not been switched off.

### **Daytime driving lamps\***

If you desire, the light switch can be left in the second position: when the ignition is switched off, the external lighting is also switched off.



You can have the activation settings for the daytime driving lamps programmed on your vehicle. ◀

### **Automatic headlamp control\***



When the switch is set to this position, the system automatically activates and cancels the low beams in response to changes in ambient light – in tunnels, at dusk, etc. – and in the event of rain and snow.



The vehicle's external lights remain on constantly when you switch on the front fog lamps after the headlamps have come on automatically. ◀



Automatic headlamp control cannot serve as a substitute for the driver's judgement in determining when the vehicle lights should be switched on. For example, the sensors are not able to detect fog. To avoid safety risks, you should respond to these kinds of low-visibility situations by switching the headlamps on manually. ◀



You can have the sensitivity of your vehicle's automatic headlamp control adjusted. ◀

## Instrument lighting

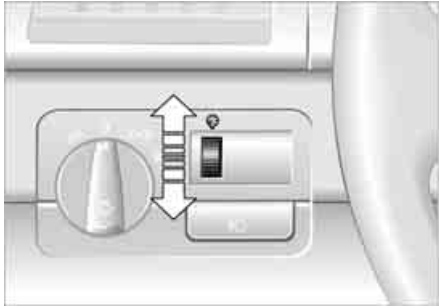

Turn the rotary dial to adjust the illumination intensity.

## High beams/Standing lamps

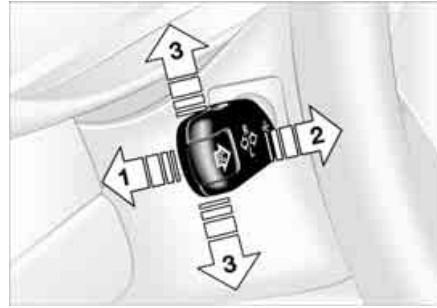

- 1 High beams – blue indicator lamp
- 2 Headlamp flasher – blue indicator lamp
- 3 Parking lamps

### Standing lamps, left or right

As an additional feature, you can illuminate your vehicle on either side for parking:

With the ignition key in position 0, engage the lever in the appropriate turn-signal position.



### Front fog lamps



The green indicator lamp in the instrument cluster lights up to indicate that the front fog lamps are on.



If the automatic headlamp control is on, the low beams will come on automatically whenever you activate the front fog lamps. ◀

## Interior lamps



The interior lamps operate automatically.

### To switch the interior lamps on and off manually

Press button 1 briefly:

If you want the interior lamps to remain off all the time, press and hold the button for approx. 3 seconds.

Press the button briefly to revert to normal operation.

### Front reading lamps\*

Switch on and off with the button 2 adjacent to each lamp.



### Rear reading lamps

Switch on and off with the button adjacent to each lamp.



In order to prevent battery discharge, all of the lamps in the vehicle are automatically switched off approx. 15 minutes after you turn the ignition key to position 0. ◀

### Light-emitting diodes

Light-emitting diodes (LEDs) installed behind translucent lenses serve as the light sources for many of the controls and displays in your vehicle. These light-emitting diodes are related to conventional lasers, and legislation defines them as light-emitting diodes, Class 1.



## Interior lamps



Do not remove the protective lens and avoid staring directly at the unfiltered beam for several hours, as inflammation of the retina could result. ◀

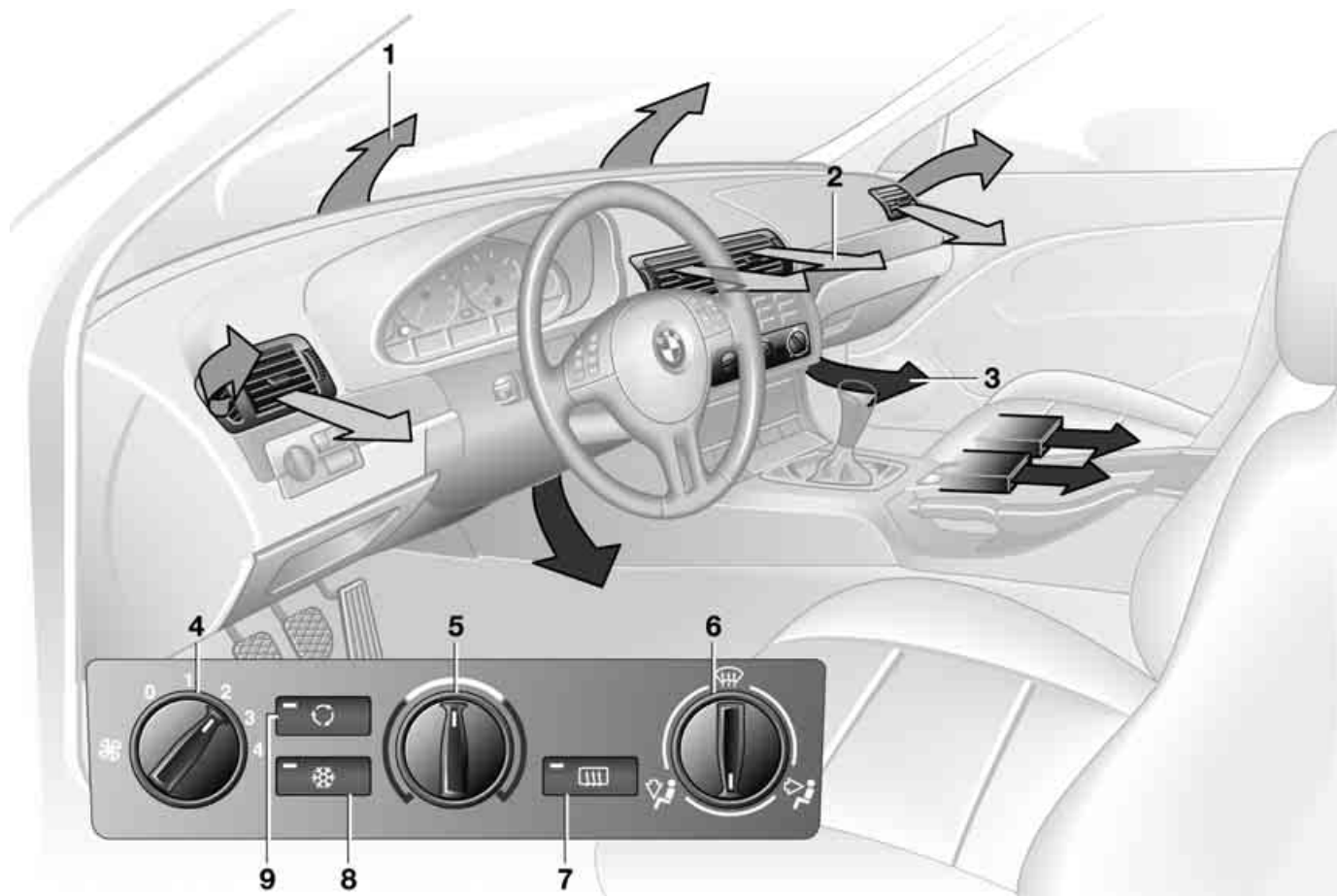

# Air conditioning

- 1 Air onto the windshield and the side windows
- 2 Air for the upper body area [101](#)
- 3 Air to the footwell
- 4 Air supply/Blower [100](#)
- 5 Temperature [100](#)
- 6 Air distribution [100](#)
- 7 Rear window defroster [100](#)
- 8 Air conditioning [100](#)
- 9 Outside air/Recirculated-air mode [100](#)





**Air supply/Blower**

You can select blower speeds from 1 to 4. The heating and ventilation become more and more effective as the air supply settings are increased. In position 0, the blower and the heater are switched off. The outside air supply is blocked in position 0.

**Temperature**

In order to increase the temperature of the passenger compartment, turn to the right toward the red zone. The temperature of the incoming air is kept constant.

**Air distribution**

You can direct air to flow onto the windows , toward your upper body  or into the footwell . All intermediate settings are possible. In the setting , there is a low flow of air onto the windows to keep them free of condensation.

**Rear window defroster**

When the rear window defroster is activated, the indicator lamp comes on. The rear window defroster switches off automatically.



You can have your vehicle programmed in such a way that the rear window defroster switches on automatically. This occurs within 5 minutes after starting the engine when outside temperatures are below approx. 39 °F/+4 °C. ◀

**Air conditioning**

The air is cooled and dehumidified and – depending on the temperature setting – rewarmed.

Depending on the weather, the windshield may fog over briefly when the engine is started. Air conditioning helps prevent the windows from fogging up.



Condensation forms during operation of the air conditioning system, which then exits under the vehicle. Traces of condensed water of this kind are thus normal. ◀

**Outside air/Recirculated-air mode**

You can respond to unpleasant external odors by temporarily blocking the supply of outside air. The system then recirculates the air currently within the vehicle.



If the windows should fog over in the recirculated-air mode, switch this mode off and increase the air supply as required. ◀

## Air conditioning

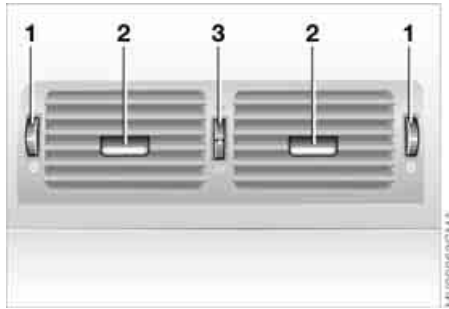

### Microfilter

The built-in microfilter removes dust and pollen from the incoming air. Your BMW center will replace it during routine maintenance. A substantial reduction in airflow indicates that the filter needs to be replaced before scheduled maintenance.

### Draft-free ventilation

You can adjust the blower controls for the upper body area to obtain the optimum airflow rates and directions for your personal requirements:

- 1 Rotary dials for infinitely variable opening and closing of the vent outlets
- 2 Levers for airflow direction
- 3 Rotary dial allows you to control the temperature of the airflow from these outlets as desired



### To defrost windows and remove condensation

1. Set the blower speed control for the air supply to position 4
2. Turn the rotary temperature control completely to the right to the red zone
3. Turn the rotary control for air distribution to position 
4. Switch on the rear window defroster to defrost the rear window.

## 102 Automatic climate control\*

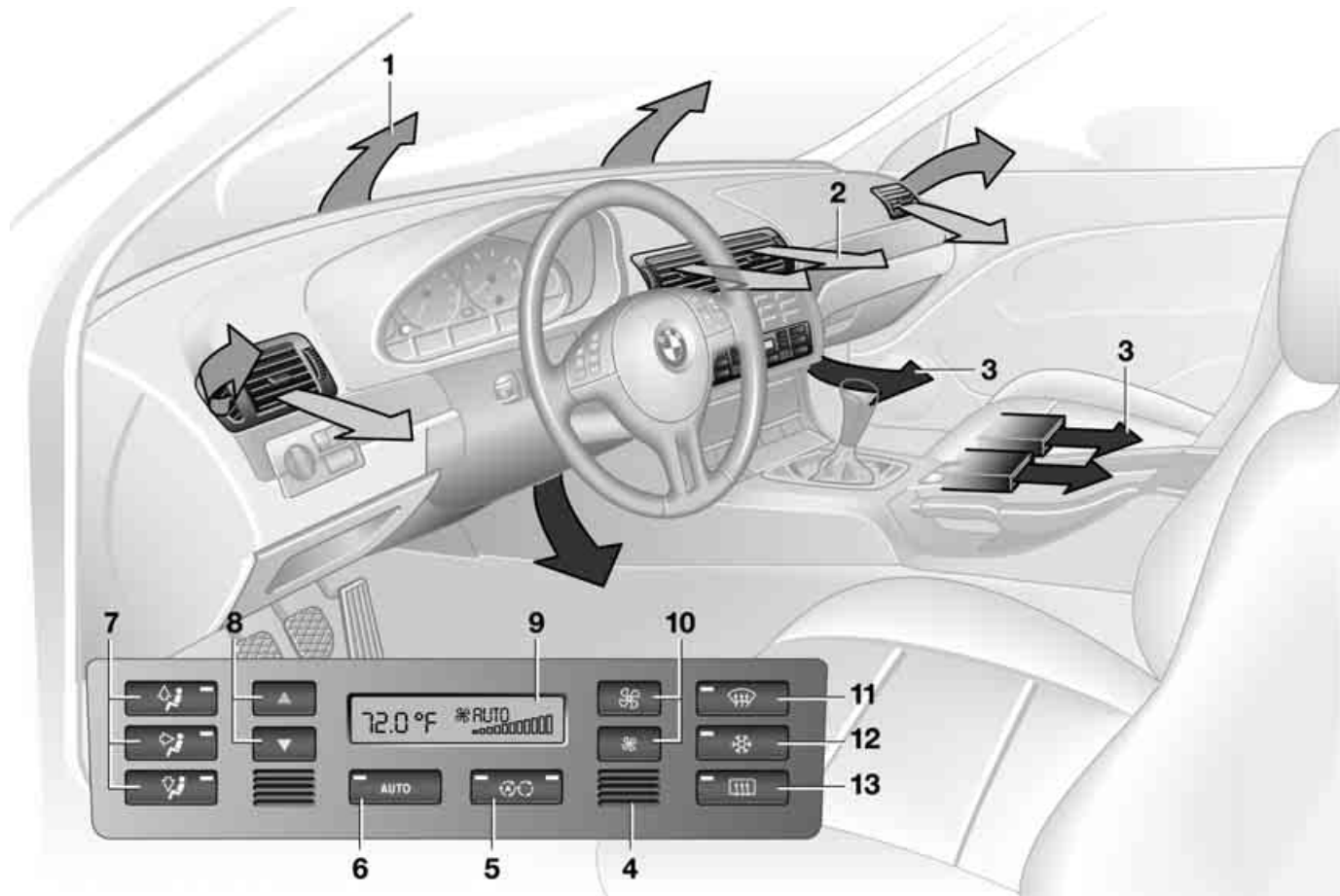

- 1 Air onto the windshield and the side windows
- 2 Air for the upper body area [105](#)
- 3 Air to the footwell
- 4 Air inlet for interior temperature sensor – please keep clear and unobstructed
- 5 Outside air/Automatic recirculated-air control (AUC)/Recirculated air [105](#)
- 6 Automatic air distribution and supply [104](#)
- 7 Individual air distribution [104](#)
- 8 Temperature [104](#)
- 9 Display for temperature [104](#) and air supply [104](#)
- 10 Air supply/Blower [104](#)
- 11 To defrost windows and remove condensation [104](#)
- 12 Air conditioning [104](#)
- 13 Rear window defroster [105](#)

**Tips for pleasant driving**

Use the automatic mode – switch on with AUTO button 6. Select the desired interior temperature.

Detailed setting options are described for you in the following section.





You can make the settings of your vehicle in such a manner that, when you unlock the vehicle with the remote control of your personal key, your own personalized setting for the automatic climate control is initiated. ◀

**Automatic air distribution and supply**

The AUTO program adjusts the air distribution and the air supply for you and in addition adapts the temperature to external influences – summer, winter – to meet preferences you can specify.

**Individual air distribution**

You can cancel the AUTO program by selecting specific distribution patterns to suit your own individual requirements. While the AUTO program is then deacti-

vated, the automatic airflow control remains in operation. Air flows onto the windows , toward the upper body , and into the footwell .

You can reactivate the automatic air distribution mode by selecting the AUTO button.

**Temperature**

The interior temperature that appears in the display panel is a general figure intended for reference purposes. We recommend 72 °F / +22 °C as a comfortable setting, even if the air conditioning is on. When you start the vehicle, the system ensures that the selected temperature is achieved as quickly as possible. It then maintains this temperature, regardless of the season.

To select the units of measure, °C or °F, for the display, refer to page 84.

**Air supply/Blower**

By pressing the upper or lower button, you can vary the air supply. This deactivates the automatic control of the air supply, AUTO disappears from the display panel. Nev-

ertheless, the automatic air distribution remains unchanged. You can reactivate the automatic air distribution mode by selecting the AUTO button.

When the lowest blower speed is set and you press the lower button, all of the displays are canceled: the blower, heating and air conditioning are switched off. The outside air supply is blocked. You can reactivate the system by pressing any button for the automatic climate control.

**To defrost windows and remove condensation**

This program quickly removes ice and condensation from the windshield and the side windows.

**Air conditioning**

The air is cooled and dehumidified and – depending on the temperature setting – rewarmed.

Depending on the weather, the windshield may fog over briefly when the engine is started. Air conditioning helps prevent the windows from fogging up.



## Automatic climate control\*

 Condensation forms during operation of the air conditioning system, which then exits under the vehicle. Traces of condensed water of this kind are thus normal. ◀

### Outside air/Automatic recirculated-air control (AUC)/ Recirculated air

 You can respond to unpleasant external odors or pollutants by temporarily stopping the flow of outside air. The system then recirculates the air currently within the vehicle.

Press the button repeatedly to select one of three different operating modes.

- ▷ Indicator lamps off: outside airflow is on
- ▷ Left indicator lamp on – AUC mode: the system recognizes pollutants in the outside air and blocks the flow of air when necessary. The system then recirculates the air currently within the vehicle. Depending on the air quality, the automatic system then switches back and forth between outside air supply and recirculation of the air within the vehicle
- ▷ Right indicator lamp on: the flow of external air into the vehicle is permanently blocked. The system then

recirculates the air currently within the vehicle.

 If the windows should fog over in the recirculated-air mode, switch this mode off and increase the air supply as required. ◀

### Rear window defroster

 When the rear window defroster is activated, the indicator lamp comes on. The rear window defroster switches off automatically.

 You can have your vehicle programmed in such a way that the rear window defroster switches on automatically. This occurs within 5 minutes after starting the engine when outside temperatures are below approx. 39°F/+4°C. ◀

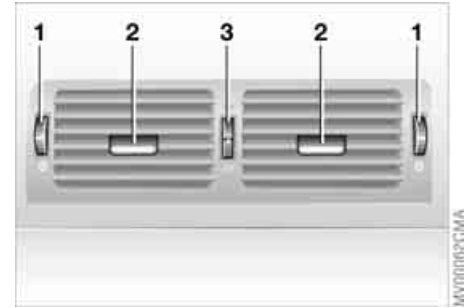

### Draft-free ventilation

You can adjust the blower controls for the upper body area to obtain the optimum airflow rates and directions for your personal requirements:

- 1 Rotary dials for infinitely variable opening and closing of the vent outlets
- 2 Levers for airflow direction
- 3 Rotary dial allows you to control the temperature of the airflow from these outlets as desired

### **Microfilter/activated-charcoal filter**

The built-in microfilter removes dust and pollen from the incoming air. The activated-charcoal filter provides additional protection by filtering gaseous pollutants from the outside air. Your BMW center replaces this combined filter as a standard part of your scheduled maintenance. A substantial reduction in airflow indicates that the filter needs to be replaced before scheduled maintenance.

### **Roller sun blind\***



To actuate, press the button briefly with the ignition key in position 1 or higher.

The illustration depicts the arrangement of the buttons if the vehicle is fully equipped. The arrangement may vary depending on the equipment actually installed.

## Premium sound system\*



### Harman Kardon premium sound system

Press the button to activate and deactivate the acoustic enhancement.

The system creates the acoustic impression of a much larger passenger compartment accompanied by improved stereophonic sound at all seating positions.

The system responds to poor reception conditions by repeatedly alternating between the stereo and monophonic modes. You should then switch the system off.

## Glove compartment

107

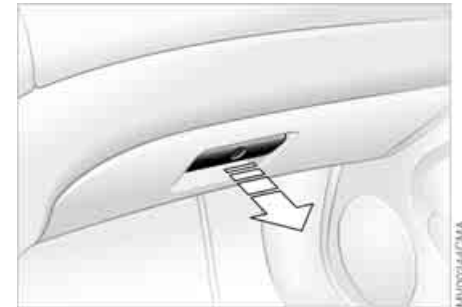

### To open

Pull the handle. The lamp in the glove compartment comes on.

### To close

Fold the cover up.

 To prevent injury in the event of an accident, close the glove compartment immediately after use. ◀

### To lock

Lock with one of the master keys. A master key will also be required to unlock the glove compartment.

 If – for example for valet parking – you turn over only your spare key, refer to page 32, then access to the locked glove compartment is not possible. ◀

### Rechargeable flashlight

The flashlight is located on the left side of the glove compartment.

It features integral overload-protection, so it can be left in its holder continuously.

 To avoid completely discharging and possibly damaging the flashlight, always ensure that it is switched off before inserting it in the socket. ◀

## Storage compartments



MV01004CMAA

### Front center armrest

To open: press the button and fold up.

### Additional compartments and nets\*

You will find additional storage compartments in the front doors and in the center console. Storage nets are on the front seat backrests.

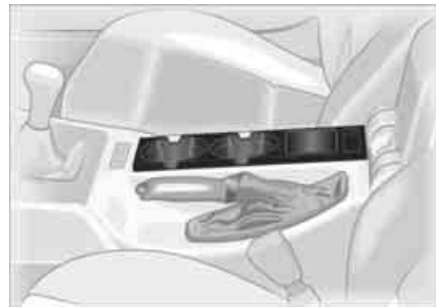

MV01005CMAA

### Beverage holders, coin box

A coin box and two beverage holders are provided in the center console.

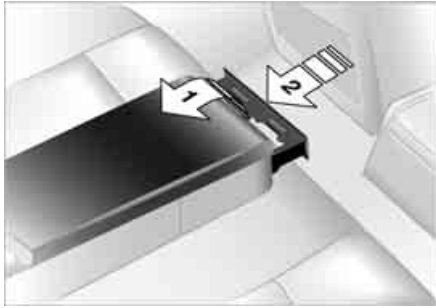

## Rear center armrest\*

Without through-loading system:

The rear center armrest includes a storage compartment, a beverages holder and a litter bag holder.

- 1 Storage compartment: pull up
- 2 Beverages holder: press

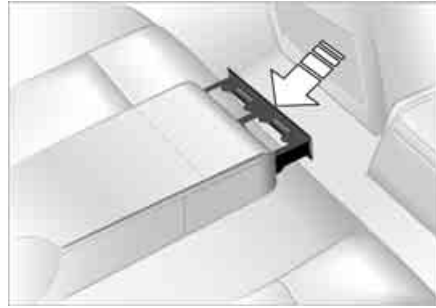

## Rear center armrest\*

With through-loading system:

The rear center armrest includes a beverages holder and a litter bag holder.

- ▷ Beverages holder: press



## Storage package\*

For your convenience, there are:

- ▷ Two flip-out sockets on the rear center console
- ▷ An eyeglasses compartment\*, not shown, in the front center console.



### **Hands-free system**

On vehicles that are wired for a telephone\* or equipped with a communications package\*, the cover for the hands-free microphone is located in the headliner near the interior lamp.

For further information on using your cellular phone, refer to the separate Owner's Manual for the telephone.

### **Ashtray, front\***



### **To empty**

Press on the edge of the open cover: the ashtray moves up and can be removed.

### **Cigarette lighter**

 Hold or touch the hot cigarette lighter by the knob only. Holding or touching it in other areas could result in burns.

The cigarette lighter remains operational when the ignition key has been removed. For this reason, children should never be left in the vehicle unattended. ◀

Press lighter 1 in. You can remove the lighter from its socket for use as soon as it springs back out.

### **Cigarette lighter socket**

Suitable for attaching power supplies for flashlights, car vacuum cleaners, etc., up to a rating of approx. 200 watts at 12 volts. Avoid damage to the socket caused by inserting plugs of different shapes or sizes.

## Ashtray, rear\*



### To empty

Press on the edge of the open cover in the opening direction: the ashtray moves up and can be removed.

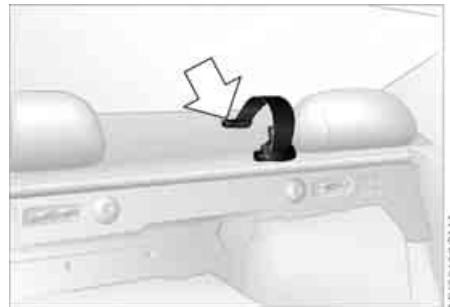
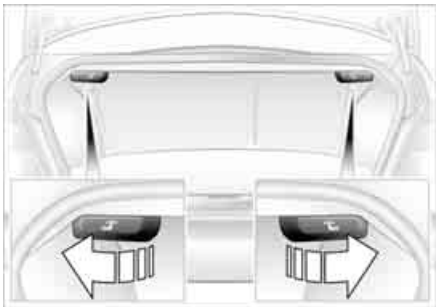

1. Pull the corresponding lever to release

2. The backrest moves forward slightly when released. Reach into the gap and fold it down.

**⚠** When folding the backrest back into its original position always ensure that the detent engages securely. A loose backrest might fail to prevent cargo from entering the passenger compartment during sudden braking or evasive maneuvers, posing a potential hazard to occupants. ◀

The fittings at the corners of the luggage compartment provide you with a convenient means of attaching luggage compartment nets\* and flexible straps for securing luggage.

Refer also to Cargo loading on page 114.

### **Rear center 3-point safety belt\***

You can roll up the rear 3-point belt before folding back the through-loading system:

- ▷ Release the belt and insert its latch in the recess provided for this purpose in the rear tray.



## Ski bag\*

The ski bag allows the safe and clean transport of up to 4 pairs of standard skis or up to two snowboards.

The length of the ski bag and the additional space provided in the luggage compartment make it possible to carry skis up to 6 ft 10 in / 2.10 m long. Because of the tapered shape of the bag, only two pairs of skis longer than 6 ft 10 in / 2.10 m can be carried.

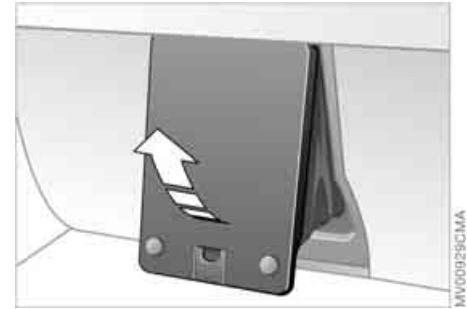
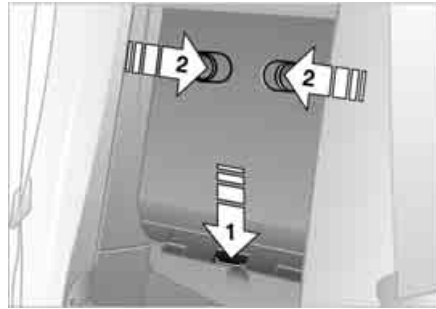

### Loading

Vehicles without through-loading system:

1. Fold the center armrest outward.  
Loosen the trim from the upper Velcro® fastener and place it on the armrest
2. Press the button – see arrow 1, from inside the passenger compartment: this releases the cover panel in the luggage compartment
3. Press the detent levers inward – see arrows 2 – and fold the cover to the front
4. Extend the ski bag between the front seats. The zipper provides convenient access to stored items. It may be opened to allow the ski bag to dry

5. Use the magnetic retainers to attach the cover panel to the upper surface – metal surface below rear tray – of the luggage compartment.

To store the ski bag, perform the above steps in reverse sequence.

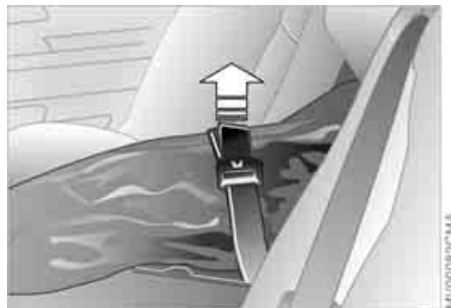

### Loading

Vehicles with through-loading system:

1. Fold the center armrest outward. Loosen the trim from the upper Velcro® fastener and place it on the armrest
2. Press the button downward – see arrow 1 – and swing the cover forward
3. Extend the ski bag between the front seats. The zipper provides convenient access to stored items. It may be opened to allow the ski bag to dry
4. Press the button – see arrow 2: the cover in the luggage compartment is unlocked.

To store the ski bag, perform the above steps in reverse sequence.

### Cargo loading

 Avoid overloading the vehicle so that the permitted load on the tires is not exceeded. Overloading can lead to overheating and internal tire damage. The ultimate result can assume the form of a sudden air loss. ◀

### Securing cargo

 Secure skis and any other objects stored in the bag by tightening the retaining strap at the buckle. ◀

 Be sure that your skis are clean before loading them into the bag. Avoid damage from sharp edges during loading. ◀

# Cargo loading

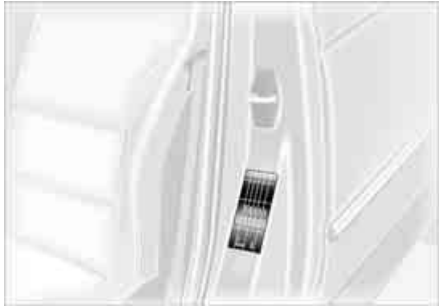

## Determining the maximum load

1. Locate the following statement on your vehicle's placard\*:

 The combined weight of occupants and cargo should never exceed XXX kg or YYY lbs., as this could otherwise result in damage to the vehicle or unstable driving conditions. ◀

2. Determine the combined weight of the driver and passengers that will be riding in your vehicle
3. Subtract the combined weight of the driver and passengers from XXX kilograms or YYY pounds

4. The resulting figure equals the available amount of cargo and luggage load capacity.  
For example, if the XXX amount equals 1,400 lbs. and there will be five 150 lbs. passengers in your vehicle, the amount of available cargo and luggage load capacity is 650 lbs.:  
 $1,400 \text{ lbs.} - 750 \text{ lbs.} = 650 \text{ lbs.}$
5. Determine the combined weight of luggage and cargo being loaded on the vehicle. That weight may not safely exceed the available cargo and luggage load capacity calculated in Step 4
6. If your vehicle will be towing a trailer, load from your trailer will be transferred to your vehicle. Consult the manual for transporting a trailer to determine how this may reduce the available cargo and luggage load capacity of your vehicle.

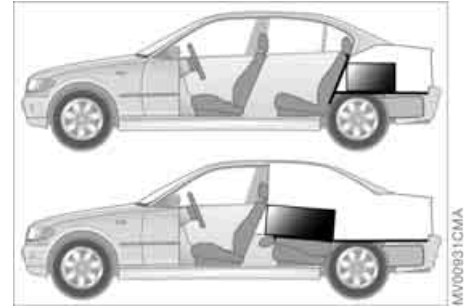

## Stowing cargo

- ▷ Load heavy cargo as far forward as possible – directly behind the backrests or the luggage compartment partition – and as low as possible
- ▷ Cover sharp edges and corners
- ▷ Do not pile objects higher than the top edge of the backrest

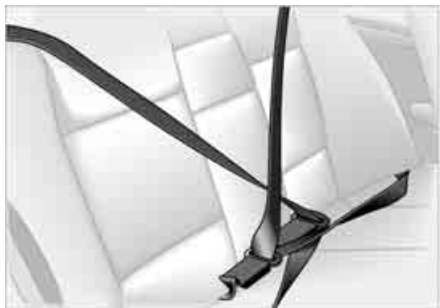

- ▷ For transporting very heavy loads when the rear seat is not occupied, secure the outer safety belts in the opposite buckles, refer to the illustration.

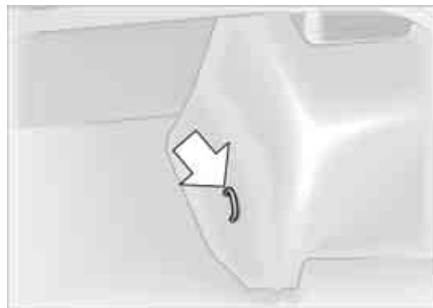

### **Securing cargo**

- ▷ For small, light items, use the rubber-lined, non-skid side of the floor mat or secure using a luggage compartment net\* or elastic straps, refer to page 40
- ▷ For large, heavy pieces, see your BMW center for load-securing devices\*. Anchorages located in the luggage compartment can be used for fastening the load-securing devices.

Read and comply with the instructions enclosed with the load-securing devices.

- ⚠ Always position and secure loads correctly. If you do not, the load can endanger the passengers during braking or evasive maneuvers. Do not exceed the approved gross vehicle weight or the approved axle loads, refer to page 162. Otherwise the vehicle's operating safety is no longer assured and the vehicle will not be in compliance with the certification regulations. Do not stow heavy or hard objects in the passenger compartment without securing them. Otherwise they would be thrown around during braking and evasive maneuvers and could endanger the passengers. ◀

## Roof-mounted luggage rack\*

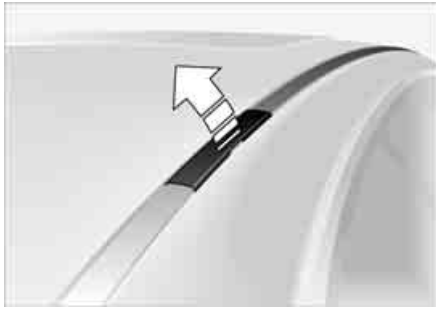

A special roof-rack system is available as an optional extra for your BMW. Please observe the precautions included with the installation instructions.

### Anchorage

Access to the anchorages:

To fold up the covers, please use the tool provided with the roof-rack system.

### Loading and driving notes

Roof-mounted luggage racks raise the center of gravity of the vehicle when they are loaded. For this reason, they exercise a major effect on the vehicle's handling and steering response.

You should therefore always remember not to exceed the approved roof load capacity, the approved gross vehicle weight or the axle loads when loading the rack. These weights are listed under Technical data on page 162.

Make sure that the load is not too heavy, and attempt to distribute it evenly. Always load the heaviest pieces first so that they are at the bottom. Be sure that adequate clearance is maintained for raising the glass sunroof, and that objects do not project into the opening path of the luggage compartment lid.

Secure the roof-mounted luggage correctly and securely to prevent it from shifting or being lost during driving.

Drive smoothly and avoid sudden acceleration and braking. Do not corner at high speeds.

The roof-mounted luggage rack and the roof load increase the aerodynamic resistance: increased fuel consumption and additional stress on the vehicle's body are the result.



## Overview

## Controls and features

## Operation, maintenance

## Owner service procedures

## Technical data

## Index



To ensure that your vehicle provides maximum economy throughout a long service life, we request that you observe the following suggestions.

### **Engine and differential**

Up to 1,250 miles/2,000 km:

Constantly vary both vehicle and engine speeds, remembering not to exceed 4,500 rpm or vehicle speeds of over 100 mph / 160 km/h:

Obey your local and state maximum speed limits.

Do not use full throttle, and avoid pressing the accelerator beyond the kickdown point during these initial miles.

You can then proceed to increase engine or vehicle speeds once the initial 1,250 miles/2,000 km have elapsed.

Please remember to observe these same break-in procedures if either the engine or the differential should have to be replaced later in the course of the vehicle's service life.

### **Tires**

Due to technical factors associated with their manufacture, tires do not achieve their full traction potential until an initial break-in period has elapsed. Thus drive with extra care during the initial 200 miles/300 km.

Obey your local and state maximum speed limits.



When the vehicle is operated on wet or slushy roads, a wedge of water may form between the tire and the road surface. This phenomenon is referred to as hydroplaning, and can lead to partial or complete loss of traction, as well as loss of vehicle control and braking effectiveness. Reduce your speed on wet roads. ◀

### **Brake system**

Approx. 300 miles/500 km must elapse before the brake pads and rotors achieve the optimal pad-surface and wear patterns required for trouble-free operation and long service life later on.

To break in the separate parking brake drums, apply the parking brake lightly when coasting to a standstill – at a traffic signal, for instance – use caution to avoid posing a danger to other road users.

To avoid corrosion, repeat this procedure from time to time.



The brake lamps do not come on when the parking brake is set. Vacuum for the brake system servo unit on your BMW is available only when the engine is running. When you move the vehicle with the engine off – when towing, for example – substantially higher levels of pedal force will be required to brake the vehicle. ◀

### **Clutch**

Approx. 300 miles/500 km must elapse before the clutch starts to operate at optimum efficiency. Remember to engage the clutch carefully during this initial period.



## General driving notes



**Brakes:** do not rest your foot on the brake pedal while driving. Even light but consistent pedal pressure can lead to high temperatures, brake wear and possibly even brake failure.

**Hydroplaning:** when driving on wet or slushy roads, reduce road speed. If you do not, a wedge of water can form between tires and road surface. This phenomenon can lead to partial or complete loss of contact between the tires and road surface, as well as loss of vehicle control and braking ability.

**Driving through water:** do not drive through water on the road if it is deeper than 1 ft/30 cm, and then only at walking speed. Otherwise, the vehicle's engine, the electrical systems and the transmission may be damaged.

**Rear parcel tray:** never use it to store heavy or hard objects; otherwise, occupants could be injured if the vehicle is braked hard.

**Clothes hooks:** when hanging clothing from the hooks, be sure that they will not obstruct the driver's vision. Do not hang heavy objects on the hooks. If you do so, they could cause personal injury during braking or evasive maneuvers. ◀

## Antilock Brake System (ABS)

### The concept

ABS keeps the wheels from locking during braking, thereby enhancing active driving safety.

### Braking with ABS

If you are in a situation that requires full braking, you will exploit the full benefits of the ABS system if you apply maximum pedal pressure – panic stop. Since the vehicle maintains steering responsiveness, you can avoid possible obstacles with a minimum of steering effort, despite the full brake application.

Pulsation at the brake pedal combined with sounds from the hydraulic circuits indicates to the driver that ABS is in its active mode.

### Dynamic Brake Control (DBC)

DBC is included in the DSC, refer to page 87.

The system responds to sudden, high-intensity applications of force to the brake pedal by automatically braking the vehicle with maximum boost to achieve the shortest possible braking distances during panic stops. This system exploits all the benefits of ABS.

Do not reduce the pressure exerted against the brake pedal until the braking maneuver has been completed. DBC is deactivated when you release the brake pedal.

### Cornering Brake Control (CBC)

CBC is an advanced engineering design of the ABS. When braking while cornering at high speed or braking during high lateral acceleration, or when braking during a lane change, vehicle stability is improved and steering response is enhanced.

**Brake fluid level**

Low brake fluid level in the reservoir combined with longer than usual pedal travel may indicate a defect in one of the brake system's hydraulic circuits.

 Proceed to the nearest BMW center. It may be necessary to apply higher levels of pressure to the pedal when stopping and braking distances may also be longer. Please remember to adapt your driving style accordingly. ◀

**Disc brakes**

When the vehicle is driven only occasionally, during extended periods when the vehicle is not used at all, and in operating conditions where brake applications are less frequent, there is an increased tendency for corrosion of the rotors and accumulation of contamination on the brake pads. This occurs because the minimal pressure that must be exerted by the pads to clean the rotors by brake applications is not reached.

Corrosion on brake rotors is signaled by a running or pulsation during braking; even extended subsequent braking will not cure this phenomenon.

It is a good idea to periodically dry the brakes with a gentle application when driving in rain and on wet roads. Watch traffic conditions to ensure that this maneuver does not endanger other road users. The heat generated in this process helps dry the pads and rotors to ensure that your brake system will respond with undiminished efficiency when you need it.

When descending steep hills and extended grades, downshift to a gear that will allow you to continue safely with only a minimal amount of braking. This helps avoid placing excessive loads on the brake system. Use care to avoid exceeding the approved engine-speed range, refer to page 80.



Do not coast with the clutch depressed or with the transmission or selector lever in Neutral. Do not coast with the engine shut off. The engine provides no braking effect when the clutch is depressed and there is no power-assist for braking or steering when the engine is not running. 325xi, 330xi: always refer all brake inspection and service work to your BMW center, as failure to observe the special procedures could result in damage to components of the all-wheel drive. Never allow floor mats, carpets or any other objects to protrude into the area around the accelerator, clutch and brake pedals and obstruct their movement. ◀

**Brake pads**

For your own safety: use only brake pads which BMW has approved for your specific vehicle model. BMW cannot evaluate non-approved brake pads to determine if they are suitable for use, and therefore cannot ensure the operating safety of the vehicle if they are installed. ◀

## Portable phone in the vehicle

BMW recommends using mobile communications devices, e.g. portable phones, inside the vehicle with a suitable outside antenna. Otherwise, it cannot be ruled out that the vehicle electronics and portable phone may interfere with each other.

**Information for your safety**

The factory-approved tires are matched to your vehicle and have been selected to provide optimum safety and driving comfort when used properly.

It is not merely the tire's service life, but also driving comfort and – above all else – driving safety that depend on the condition of the tires and the maintenance of the specified tire inflation pressure.

Incorrect tire inflation pressure is a frequent cause of tire damage. Tire pressure also has a major effect on your BMW's handling response.



Be sure to check the tire inflation pressure, including the space-saver spare tire or the spare tire, on a regular basis, at least twice a month and before every extended journey, refer to page 25. If this is not done, incorrect tire pressures can cause driving instability and tire damage, ultimately resulting in accidents. ◀

**Tire condition**

wall with TWI – Tread Wear Indicator. At a tread depth of 1/16 in / 1.6 mm, the indicators signal that the legally permissible wear limit has been reached.

**Tire tread – tire damage**

Inspect your tires frequently for tread wear, signs of damage and for foreign objects lodged in the tread. Check the tread depth.

Tread depth should not be allowed to go below 1/8 in / 3 mm, even though the legally specified minimum tread depth is 1/16 in / 1.6 mm.

Below 1/8 in / 3 mm tread depth, there is a great risk of hydroplaning, even at relatively moderate speeds and with only small amounts of water on the road. Tread wear indicators in the tread-groove base – see arrow – are distributed around the wheel circumference and are labeled on the tire side-

## Tire condition

 Do not drive on a flat tire unless your vehicle is equipped with Run Flat tires. A flat tire greatly impairs steering and braking response, and can lead to complete loss of control over the vehicle. Avoid overloading the vehicle so that the permitted load on the tires is not exceeded. Overloading can lead to overheating and internal tire damage.

The ultimate result can assume the form of a sudden air loss.

Unusual vibrations encountered during normal vehicle operation can indicate a flat tire or some other vehicle malfunction. This type of problem can be caused by contact with curbs, etc. This is also true for abnormalities in the vehicle's handling characteristics, such as a pronounced tendency to pull to the left or right. Should this occur, respond by immediately reducing your speed. Proceed carefully to the nearest BMW center or professional tire center, or have the vehicle towed in to have it, its wheels or its tires inspected.

Tire damage up to and including sudden and complete air loss can endanger the lives of both the vehicle occupants and other road users. ◀

## Tire replacement

To maintain good handling and vehicle response, use only tires of a single tread configuration from a single manufacturer.

Comply with the specified tire inflation pressures – and be sure to have the wheel and tire assembly balanced every time you change a tire or wheel.

### DOT quality grades

Tread wear

Traction AA A B C

Temperature A B C

 All passenger car tires must conform to Federal Safety Requirements in addition to these grades. ◀

### Tread wear

The tread wear grade is a comparative rating based on the wear rate of the tire when tested under controlled conditions on a specified government test course.

For example, a tire graded 150 would wear one and one-half –  $1\frac{1}{2}$  – times as well on the government course as a tire graded 100. The relative performance of tires depends upon the actual conditions of their use, however, and may

depart significantly from the norm due to variations in driving habits, service practices and differences in road characteristics and climate.

### Traction

The traction grades, from highest to lowest, are AA, A, B, and C.

Those grades represent the tire's ability to stop on wet pavement as measured under controlled conditions on specified government test surfaces of asphalt and concrete. A tire marked C may have poor traction.

 The traction grade assigned to this tire is based on straight-ahead braking traction tests, and does not include acceleration, cornering, hydroplaning, or peak traction characteristics. ◀

### Temperature

The temperature grades are A – the highest – B, and C, representing the tire's resistance to the generation of heat and its ability to dissipate heat when tested under controlled conditions on a specified indoor laboratory test wheel.

Sustained high temperature can cause the material of the tire to degenerate and reduce tire life, and excessive temperature can lead to sudden tire failure. The grade C corresponds to a level of performance which all passenger car tires must meet under the Federal Motor Vehicle Safety Standard No. 109. Grades B and A represent higher levels of performance on the laboratory test wheel than the minimum required by law.

 The temperature grade for this tire is established for a tire that is properly inflated and not overloaded. Excessive speed, underinflation, or excessive loading, either separately or in combination, can cause heat buildup and possible tire failure. ◀

### **Uniform Tire Quality Grading**

Quality grades can be found where applicable on the tire sidewall between tread shoulder and maximum section width. For example:

Tread wear 200

Traction AA

Temperature A

 BMW advises against using retreaded tires, since driving safety may be impaired. This is due to the possible variations in casing structures and, in some cases, to their extreme age, which can lead to a decrease in their durability. ◀

### **Tire age**

The date on which the tire was manufactured is indicated by the code on the sidewall:

DOT... 3603 indicates that the tire was manufactured in week 36 of the year 2003.

BMW recommends the replacement of all tires – including the spare tire\* – when the tires are no more than 6 years old, even if a tire life of 10 years is possible.

### **Run Flat tires\***

Before purchasing tires, check if your BMW is equipped with Run Flat tires. These are indicated by a circular symbol containing the letters RSC on the tire sidewall, refer to Changing a wheel. In this case, use only Run Flat tires, since no spare wheel is available in the event of a flat.

For more information on Run Flat tires, refer to page 150.

 Run Flat tires are available only in combination with the Flat Tire Monitor. ◀

### The right choice

 BMW recommends using only wheels and tires that have been approved by BMW for use on your particular model. Although other wheels and tires may theoretically have the same dimensions, variations in factors such as manufacturing tolerances can result in contact between tire and bodywork, ultimately leading to serious accidents. BMW cannot evaluate all tires and wheels on the market, and is thus unable to guarantee that the vehicle will continue to perform safely if unapproved tires and/or wheels are mounted. ◀

For each tire size, BMW has assessed the safe performance of specific tire brands and approved them for use. Consult any BMW center for details. Comply with any local/national regulations, for example by recording the tire type in the vehicle documents.

 The correct wheel and tire combination affects various systems that would otherwise be impaired, for example ABS, DSC and ADB-X/DBC. For this reason, use only tires of the same manufacture and tread configuration. In the event of a flat tire, for example, remount the approved wheel and tire combination as soon as possible. ◀

### Storage

Always store tires in a cool, dry place. Store them away from light whenever possible. Protect the tires against contact with oil, grease and fuel.

Do not exceed the maximum tire inflation pressures specified on the tire sidewall.

### Choosing the right tire

BMW recommends the use of winter tires for operation under winter road conditions. While all-season tires – with M+S designation – provide better winter traction than the corresponding summer tires, they generally do not achieve the performance of winter tires.

In the interest of safe tracking and steering response, install winter tires made by the same manufacturer and having the same tread configuration on all four wheels.

 Never exceed the maximum speed for which the winter tires are rated.

Unprofessional attempts by laymen to service tires can lead to damage and accidents.

Have this work performed by trained professionals only. Any BMW center has the required technical knowledge and the proper equipment and will be happy to assist you. ◀

### Run Flat tires\*

Before purchasing winter tires, check if your BMW is equipped with Run Flat tires. These are indicated by a circular symbol containing the letters RSC on

the tire sidewall, refer to Changing a wheel. In this case, use only Run Flat winter tires, since no spare tire is provided in the event of a flat tire.

### **Tire condition, tire pressure**

At tread depths below approx. 3/16 in / 4 mm, winter tires display a perceptible decrease in their ability to cope with winter driving conditions, and should be replaced in the interest of safety.

Comply with the specified tire inflation pressures – and be sure to have the wheel and tire assembly balanced every time you change a tire or wheel.

### **Snow chains\***

Only certain snow chains have been tested by BMW and determined and approved as roadworthy. Consult any BMW center for details. BMW recommends using only these approved fine-link snow chains. Use them in pairs on either summer or winter tires, but only on both rear wheels.

325xi, 330xi: only in an emergency – for instance, with the vehicle stuck on one side, or when obstructions make it impossible to reach one tire – a chain may also be mounted on just one tire for the limited period needed to resolve the problem.

Comply with all manufacturer's safety precautions when mounting the chains. Do not exceed a speed of 30 mph / 50 km/h when using snow chains.

You cannot mount snow chains on the following tires:

225/50 R 16

225/45 R 17

225/40 R 18

245/40 R 17

255/35 R 18



Do not initialize the Flat Tire Monitor after mounting snow chains to the tires.

When driving with snow chains, it may be useful to turn off the DSC for a short time, refer to page [88](#) or [89](#). ◀





## To release

Pull the lever located under the left-hand side of the instrument panel.

**⚠** Do not attempt to service your vehicle if you do not have the required technical background. Failure to work in an informed, professional manner when servicing components and materials constitutes a safety hazard for vehicle occupants and other road users. If you are not familiar with the guidelines, BMW recommends that you have the operations performed by your BMW center. ◀

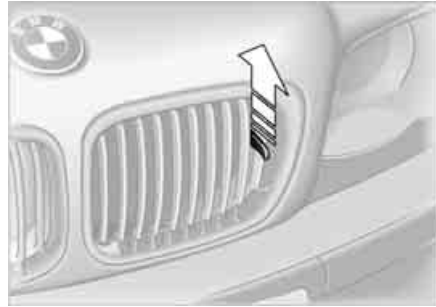

## To open

Pull the release handle and open the hood.

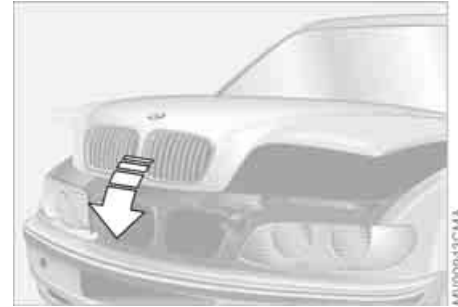

## To close

Allow the hood to fall from a height of about 1 ft/30 cm so that it audibly engages.

**⚠** To avoid injuries, be sure that the travel path of the hood is clear when it is closed, following the same safety precautions used in all closing procedures. If you notice while driving that the hood is not completely closed, stop immediately and close it securely. ◀

130 **Engine compartment essentials**

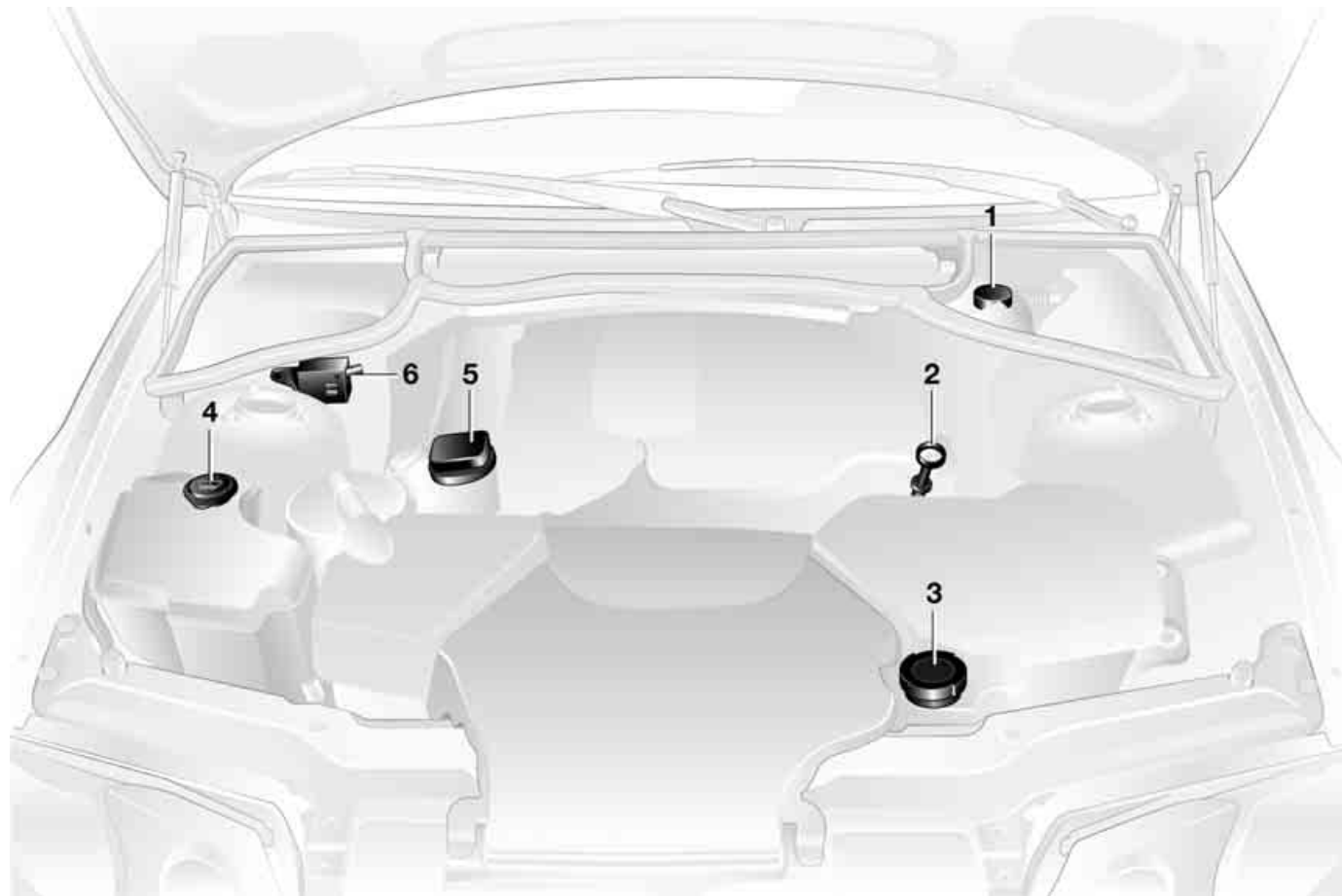

- 1 Brake fluid reservoir [134](#)
- 2 Engine oil dipstick [132](#)
- 3 Coolant expansion tank [134](#)
- 4 Reservoir for the headlamp and windshield washer system [132](#)
- 5 Engine oil filler neck [133](#)
- 6 Auxiliary terminal for jump-starting [153](#)

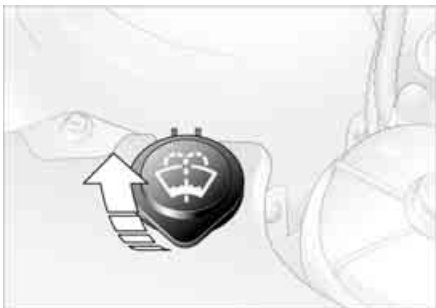

### Headlamp\* and windshield washer system

Capacity approx.  
5.6 US quarts/5.3 liters

Fill with water and, if required, with a washer antifreeze additive according to manufacturer's recommendations.



We recommend that you mix the washer fluid before adding it to the reservoir. ◀



Antifreeze agents for the washer fluid are highly flammable. For this reason, keep them away from sources of flame and store them only in their closed original containers. Store them inaccessible to children. Comply with the instructions on the containers. ◀

## Engine oil

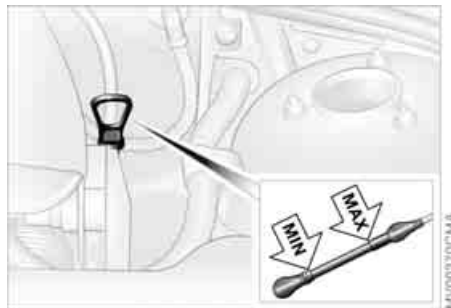

The oil volume between the two marks on the dipstick corresponds to approx. 1.1 US quarts/1 liter. Do not fill beyond the upper mark on the dipstick. Excess oil will damage the engine.

### Checking the oil level

1. Park the vehicle on a level surface
2. Switch the engine off after it has reached normal operating temperature
3. After approx. 5 minutes, pull the dipstick out and wipe it off with a clean lint-free cloth, paper towel, or similar material
4. Carefully push the dipstick all the way into the guide tube and pull it out again
5. The oil level should be between the two marks on the dipstick.

As with fuel economy, oil consumption is directly influenced by your driving style and vehicle operating conditions.

# Engine oil

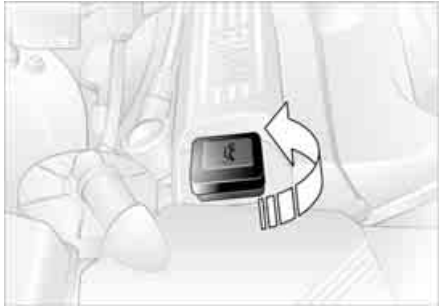

## Adding engine oil

Only add engine oil when the oil level has dropped to just above the lower mark on the dipstick.

**!** BMW engines are designed to operate without oil additives; the use of additives could lead to damage in some cases. This also applies to the manual transmission, the automatic transmission, the differential, and the power steering system. ◀

Recommendation: have the oil changed at your BMW center.

**!** Continuous exposure to used oil has caused cancer in laboratory testing. For this reason, any skin areas that come into contact with oil should be thoroughly washed with soap and water.

Store oils, grease and similar materials so that they are inaccessible to children. Comply with warning labels and information on containers. ◀

**♻️** Comply with the applicable environmental laws regulating the disposal of used oil. ◀

## Specified engine oils

The quality of the engine oil is extremely important for the operation and service life of an engine. Based on extensive testing, BMW has approved only certain grades of engine oil.

Use only approved BMW High Performance Synthetic Oil.

If an approved BMW High Performance Synthetic Oil should be unavailable, you may use small volumes of other synthetic oils for topping up between oil changes. Use only oils with the specification API SH or higher.

**▶** Ask your BMW center for details concerning the specific BMW High Performance Synthetic Oil or synthetic oils that have been approved. ◀

You can also call BMW of North America toll-free at 1-800-831-1117 or visit this website: [www.bmwusa.com](http://www.bmwusa.com) to obtain this information.

## Viscosity ratings

Viscosity is the oilflow rating as established in SAE classes.

The selection of the correct SAE class depends on the climatic conditions in the area where you drive your BMW.

**▶** Approved oils are in SAE classes 5W-40 and 5W-30. ◀

These kinds of oil may be used for driving in all ambient temperatures.

 Do not add coolant to the cooling system when the engine is hot. If you attempt to do so, escaping coolant can cause burns.

Antifreeze and anti-corrosion agents are hazardous to health. You should always store them in closed original containers and in a location which is out of reach of children. Antifreeze and anti-corrosion agents are inflammable. For this reason, do not spill them on hot engine parts. They could ignite and cause serious burns. Comply with the instructions on the containers. ◀



Comply with the applicable environmental laws regulating the disposal of antifreeze agents with corrosion inhibitor. ◀



### Checking the coolant level and adding coolant

Check the coolant level when the engine is cold, approx. 68 °F / +20 °C.

1. Open the cap for the expansion tank by turning it slightly counterclockwise to allow accumulated pressure to escape, then open
2. The coolant level is correct when the upper end of the red float is at least even with the upper edge of the filler neck; see arrow. The end of the float may stick out by a maximum of 3/4 in / 2 cm – that is, up to the second mark on the float
3. If necessary, add coolant. If the coolant is low, slowly add coolant until the correct level is reached – do not overfill.

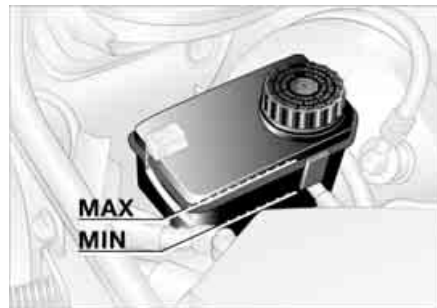

### Indicator lamp

 The brake warning lamp comes on when the parking brake is not engaged: the brake fluid level is too low, refer to page 18.



Brake warning lamp for Canadian models.

### Adding brake fluid

For adding brake fluid or for determining and correcting the cause of brake fluid loss, consult your BMW center. Your BMW center is familiar with the specifications for factory-approved brake fluids – DOT 4.

Brake fluid loss results in extended pedal travel. Refer to the information on page 122.

## Brake fluid



Brake fluid is hygroscopic, that is, it absorbs moisture from the air over time.

In order to ensure the brake system's safety and reliability, have the brake fluid changed every two years by a BMW center. Refer to the Service and Warranty Information Booklet for US models or the Warranty and Service Guide Booklet for Canadian models. Brake fluid is toxic and damages the vehicle's paint. You should always store it in its closed original container and in a location which is out of reach of children.

Do not spill the brake fluid and do not fill the brake fluid reservoir beyond the MAX mark. The brake fluid could ignite upon contact with hot engine parts and cause serious burns. ◀



Comply with the applicable environmental laws regulating the disposal of brake fluid. ◀

The BMW Maintenance System has been designed as a reliable means of providing maximum driving and operating safety – and as cost-effectively as possible for you.

Please keep in mind that regular maintenance is not only necessary for the safety of your vehicle, but also plays a significant role in maintaining the resale value of the vehicle.



### **Service interval display**

While conventional systems rely on mileage alone to determine when service is due, the BMW Maintenance System reflects the actual conditions under which the vehicle is operated: some miles are more strenuous than others.

From a maintenance point of view, 62,000 miles/100,000 km accumulated in short-distance urban driving are not the equivalent of the same distance covered at moderate cruising speeds in long-distance highway travel.

The BMW Maintenance System includes the Engine Oil Service and Inspections I and II.

This service strategy accurately reflects your own vehicle's specific needs by defining maintenance intervals according to individual operating conditions. Minimal use drivers – those who drive significantly fewer than 6,200 miles/10,000 km annually – should have the engine oil changed at least every 2 years since oil deteriorates over time, regardless of use.

### **Service and Warranty Information Booklet for US models/ Warranty and Service Guide Booklet for Canadian models**

For additional information on required maintenance intervals and procedures, please refer to the Service and Warranty Information Booklet for US models, or the Warranty and Service Guide Booklet for Canadian models.

As a precaution against corrosion, if your vehicle is exposed to potential damage from unimproved road surfaces we suggest that you have the body checked for damage from stone chips and gravel at the same time.



# The BMW Maintenance System



Have your BMW center perform maintenance and repair.

Be sure that all maintenance work is recorded in the Service and Warranty Information Booklet for US models, or in the Warranty and Service Guide Booklet for Canadian models. These entries confirm that your vehicle has benefitted from regular maintenance, and are also required for warranty claims. ◀

## Care

You can find everything you need to know on this topic by consulting the separate Caring for your vehicle brochure.

## 138 California Proposition 65 warning

California laws require us to state the following warning:

 Engine exhaust and a wide variety of automobile components and parts, including components found in the interior furnishings in a vehicle, contain or emit chemicals known to the State of California to cause cancer and birth defects and reproductive harm. In addition, certain fluids contained in vehicles and certain products of component wear contain or emit chemicals known to the State of California to cause cancer and birth defects or other reproductive harm.

Battery posts, terminals and related accessories contain lead and lead compounds. Wash your hands after handling.

Used engine oil contains chemicals that have caused cancer in laboratory animals. Always protect your skin by washing thoroughly with soap and water. ◀

## OBD interface socket



The interface socket for onboard diagnostics is located on the left-hand side of the driver's side, behind a specially marked cover located beneath the instrument panel. The cover has the letters OBD on it.

This interface makes it possible to access data on emissions-related components using special equipment.

 An illuminated indicator informs you of the need for service, not that you need to stop the vehicle. However, the systems should be checked by your BMW center at the earliest possible opportunity.

If the indicator blinks or flashes, this indicates a high level of engine misfire. Reduce speed and contact the nearest BMW center immediately. Severe

## OBD interface socket

engine misfiring for even a short period of time can seriously damage emission control system components, especially the catalytic converter.



SERVICE ENGINE SOON warning lamp for Canadian models.



If the gas cap is not on tight enough, the OBD system can detect leaking vapor and the indicator will light up. If the gas cap is then tightened, the indicator will usually go out after a short period of time. ◀

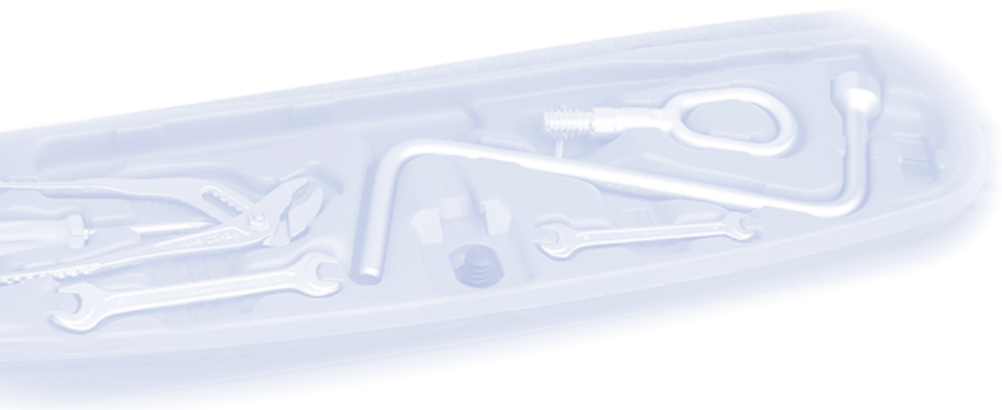



Overview

Controls and features

Operation, maintenance

**Owner service procedures**

Technical data

Index

Overview

Controls

Maintenance

Repairs

Data

Index

## 142 Onboard tool kit

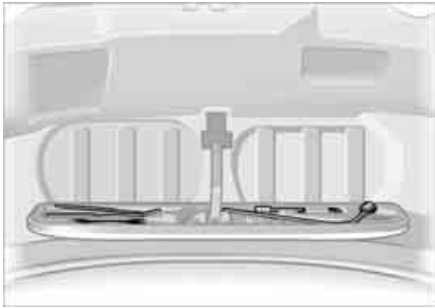

The onboard tool kit is located in the luggage compartment lid.  
Loosen the wing nut to open.

## Windshield wiper blades

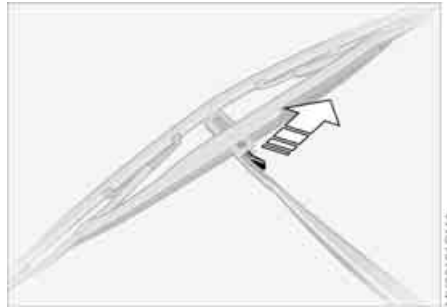

1. Switch off the engine
2. Fold the wiper arm completely out from the windshield
3. Position the wiper blade at an angle and pull the release spring – see arrow
4. Fold the wiper blade down and unhook it toward the windshield
5. Pull the wiper blade past the wiper arm toward the top
6. Insert a new wiper blade and apply pressure until you hear it engage.

## Lamps and bulbs

The lamps and bulbs make essential contributions to the safety of your vehicle. Therefore, proceed carefully when handling bulbs. BMW recommends that you have such work performed by your BMW center if you are not familiar with the procedures.

 Do not touch the glass portion of a new bulb with your bare hands since even small amounts of impurities burn in to the surface and reduce the service life of the bulb. Use a clean cloth, paper napkin, or a similar material, or hold the bulb by its metallic base. ◀

A replacement bulb set is available from your BMW center.

 Before working on the electrical system, switch off the electrical accessory you are working on or disconnect the cable from the negative terminal of the battery. Failure to observe this precaution could result in short circuits.

To prevent injuries and damage, comply with any instructions provided by the bulb manufacturer. ◀



### Low beams and high beams

Engine compartment, left side:

- 1 Low beams
  - 2 High beams
- H7 bulb, 55 watts

 The H7 bulb is pressurized. Therefore, wear safety glasses and protective gloves. Failure to comply with this precaution could lead to injury if the bulb is damaged. ◀

1. Turn the two release catches at the front to the left – see arrow – to remove the bulb holder
2. Remove and replace the bulb.

 Insert the new bulb as shown in the inset.  
When attaching the bulb holder, ensure that the lock snaps in place properly. ◀

 When cleaning the headlamps, please follow the instructions in the Caring for your vehicle brochure. ◀

### Xenon lamps\*

The service life of these bulbs is very long and the probability of a failure is very low, provided that they are not switched on and off an unusual number of times. If one of these bulbs should nevertheless fail, it is possible to continue driving with great caution using the fog lamps, provided local traffic laws do not prohibit this.

 Because of the extremely high voltages involved, any work on the xenon lighting system, including bulb-changing, should be carried out by technically-qualified personnel only. Otherwise, there is a risk of fatal injury. ◀

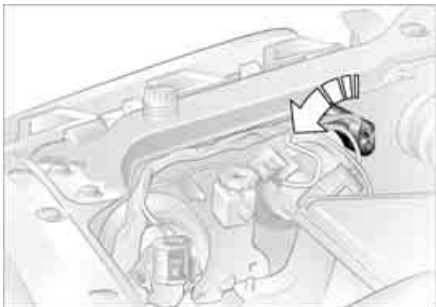

### **Parking lamps**

5 watt bulb

Engine compartment, left side:

1. Turn the bulb holder to the left and remove
2. Remove and replace the bulb.

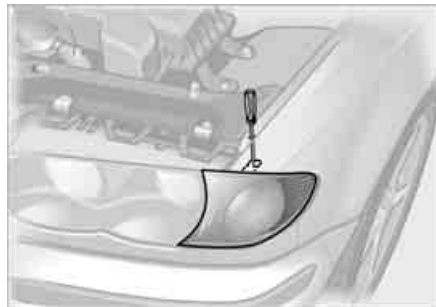

### **Front turn signal indicators**

21 watt bulb

1. Extend a screwdriver through the upper opening and loosen the screw, continuing until you can extract the bulb by removing it from the front
2. Disconnect the plug
3. Apply gentle pressure and turn the bulb toward the letters AUF – refer to the marking on the housing – then remove it for replacement
4. Connect the plug

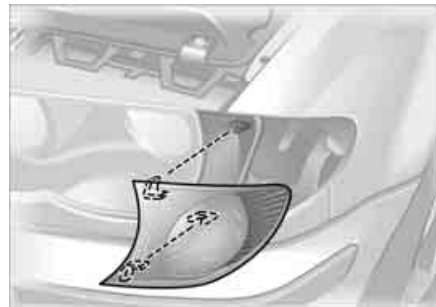

5. Align the lamp assembly's two ridges and the centering pin with the guides on the vehicle when installing
6. Slide in the lamp, applying gentle pressure to seat it firmly
7. Tighten the screw.



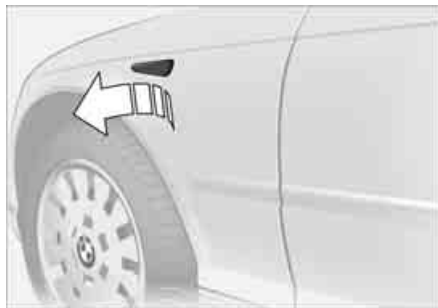

## Side turn signal indicators

5 watt bulb

1. Press the back edge of the lamp toward the front with the tip of your finger and remove
2. Apply gentle pressure to the bulb while turning it to the left to remove.

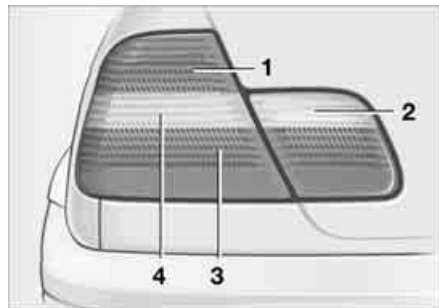

## Rear lamps

- 1 Brake lamp
  - 2 Backup lamp
  - 3 Tail lamp
  - 4 Turn signal indicator
- Bulbs: 21 watt

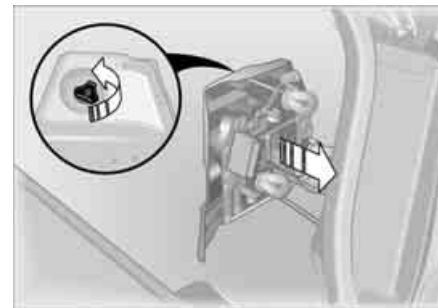

Right-hand luggage compartment opening:

Bulbs in the fender:

All of the bulbs are integrated in a central bulb holder.

1. Unscrew the bulb holder – see arrow in close-up view – to remove
2. Unplug the power supply plug. Set the bulb holder aside – on the luggage compartment floor, for example
3. Applying light pressure, turn the bulb to the left. Remove and replace the bulb
4. Plug in the power supply fitting
5. Screw the bulb holder back on – see arrow in close-up view.

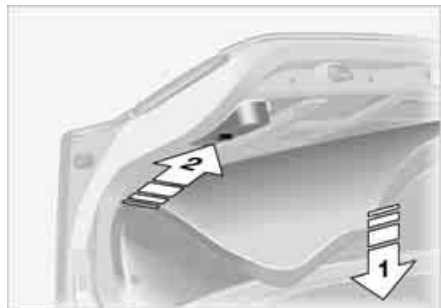

Bulbs in the luggage compartment lid:  
1. Use a screwdriver to release the two clips

2. Swing trim panel down – see arrow 1. Release the bulb holder – see arrow 2 – and remove it
3. Applying light pressure, turn the bulb to the left. Remove and replace the bulb
4. Press the bulb holder into place, continuing until you hear it engage
5. Reinstall the trim panel with the clips.

**Center high-mount brake lamp**

LED strip on the rear window.

Please contact your BMW center in case of malfunction.

## Lamps and bulbs

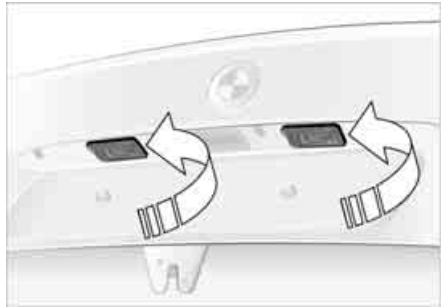

### License plate lamps

5 watt bulb

1. Place a screwdriver in the slot and press toward the left to release the lens
2. Replace the bulb.

## Changing a wheel

 Safety precautions in the event of a flat tire or wheel change: Stop the vehicle as far as possible from passing traffic. Park on a firm, flat, surface. Switch on the hazard warning flashers. Turn the steering wheel to the straight-ahead position and engage the steering lock. Shift into 1st or Reverse, or if you have an automatic transmission position the selector lever in Park, and engage the parking brake.

All passengers should be outside the vehicle and well away from your immediate working area, behind a guardrail, for example.

If a warning triangle or portable hazard warning lamp is available, set it up on the roadside at an appropriate distance from the rear of the vehicle. Comply with all safety guidelines and regulations.

Change the wheel only on a level, firm surface which is not slippery. Avoid jacking the vehicle on a soft or slippery support surface – snow, ice, loose gravel, etc. – as either the vehicle or the jack could slip sideways.

Position the jack on a firm support surface.

Do not place wooden blocks or similar objects under the jack. They could prevent the jack from extending to its full

height and reduce its support capacity. Do not lie under the vehicle or start the engine when the vehicle is supported by the jack. There is otherwise a risk of fatal injury. ◀

Your BMW is equipped with a spare tire or a space-saver spare tire designed for temporary use in maintaining the vehicle's mobility in an emergency.

 To remove the spare tire, lift the floor panel in the luggage compartment completely out, refer to page 40. ◀

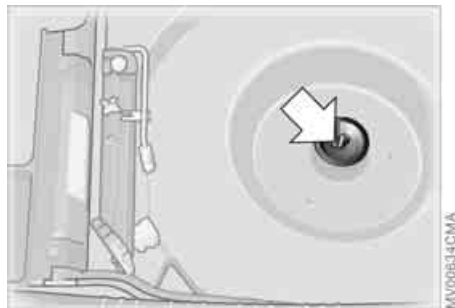
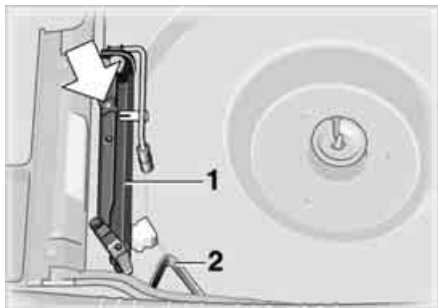

### What you will need

In order to avoid rattling noises later, note the position of the tools when you remove them and return them to their original position when you are done using them.

▷ Jack 1

Lift the floor panel within the luggage compartment, refer to page 40, and undo the red wing nut.

When you have completed work, screw the jack all the way back down. Fold the handle back and insert it in its holder

▷ Chock 2

Located behind the jack on the wall in the luggage compartment. Loosen the wing nut to remove it

▷ Spare tire or space-saver spare tire – located next to the jack

Loosen the wing nut by hand, remove the storage shelf and take the wheel out

▷ Lug wrench – in the onboard tool kit on the underside of the luggage compartment lid, refer to page 142.

### Procedure

1. Read and comply with the safety precautions provided on the previous page

2. Secure the vehicle to prevent it from rolling:

Place the wedge against the rear surface of the front tire on the side opposite the side being raised. If the vehicle is parked on a downward slope, place the wedge

securely in front of the tire. If the wheel must be changed on a surface with a more severe slope, take additional precautions to secure the vehicle from rolling

3. Wheels with full wheel covers\*: Reach into the ventilation openings and pull the cover off
4. Loosen the lug bolts by rotating half a turn

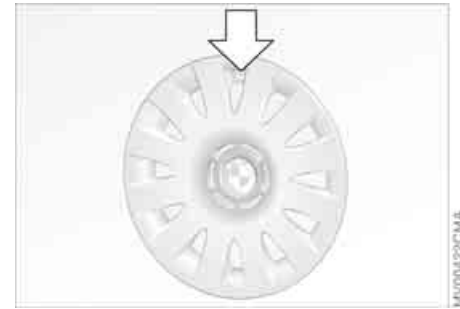
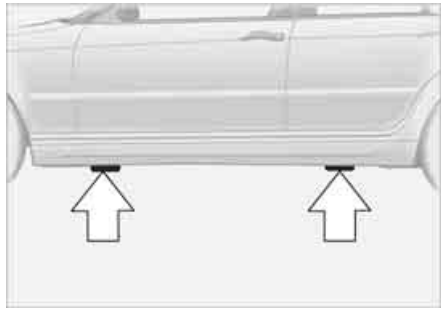

5. Position the jack at the jacking point closest to the flat tire with the jack base vertically below the jacking point and the entire surface of the head of the jack moves into the square recess of the jacking point – refer to the detail in the next illustration – when the jack is cranked
  6. Jack the vehicle up until the wheel you are changing is raised from the ground
  7. Unscrew the lug bolts and remove the wheel
  8. Remove accumulations of mud or dirt from the mounting surfaces of the wheel and hub. Clean the lug bolts
  9. Position the new wheel or the space-saver spare tire on the hub and screw at least two lug bolts finger-tight into opposite bolt holes
  10. Screw in the remaining lug bolts. Screw in all the bolts in a diagonal pattern
  11. Lower the jack and remove it from beneath the vehicle
  12. Tighten the lug bolts securely in a diagonal pattern
  13. Wheels with full wheel covers\*: place the wheel cover with the valve opening over the valve. Use both hands to press the cover securely onto the rim
  14. Check and correct the tire inflation pressure at the earliest opportunity. Vehicles with Flat Tire Monitor: after mounting the spare tire or correcting the tire inflation pressure, reinitialize the system, refer to page 92.
- Protect valve stems and valves from dirt using screw-on valve stem caps. Dirty valve stems frequently lead to slow pressure loss.

 Do not attempt to install the full wheel cover on the space-saver spare tire, since this could damage the cover. ◀

 The vehicle jack is designed for changing wheels only. Do not attempt to raise another vehicle model with it or to raise any other type of load. To do so could cause accidents and personal injury.

To ensure continued safety, have the tightness of the torque bolts checked with a calibrated lug wrench – torque specification: 88.5 lb ft/120 Nm – at the earliest opportunity. ◀

When storing a wheel in the spare tire recess, take care to avoid bending the threaded rod.

If light-alloy wheels other than original BMW light-alloy wheels have been mounted, it may be necessary to use different lug bolts for those wheels.

Replace the defective tire as soon as possible and have the new wheel/tire balanced.

### **Driving with the space-saver spare tire**

Drive cautiously. Do not exceed a speed of 50 mph / 80 km/h.

Be aware that vehicle handling may be altered. Anticipate, e.g., reduced tracking during braking, longer braking distances, and changed steering characteristics when approaching limit conditions. These handling characteristics will be even more pronounced if winter tires are mounted.

 Only one space-saver spare tire may be mounted at one time. Mount a wheel and tire of the original size at the earliest possible opportunity. ◀

### **Driving with a spare tire\***

 For certain wheel/tire combinations, the size of the spare tire will differ from that of the remaining tires. The spare tire is fully functional at all loads and speeds. However, the spare tire should be replaced at the earliest possible opportunity in order to achieve the original operating conditions. ◀

## **Run Flat tires\***



Run Flat tires are labeled on the sidewall with a circular symbol containing the letters RSC. Run Flat tires consist of self-supporting tires and special rims. The tire reinforcement ensures that driving remains possible to a restricted degree in the event of pressure drop or even if the tire is deflated.

 When mounting or replacing summer tires with winter tires, or vice versa, use Run Flat tires since no spare wheel is available in the event of a flat. In this event, BMW recommends consulting your BMW center. Your BMW center has the information needed for working with Run Flat tires and is equipped with the necessary special tools. ◀

## Run Flat tires\*

### Driving with a damaged tire

Depending on the cargo load, Run Flat tires allow you to continue driving at a maximum speed of 50 mph / 80 km/h. If there is a total loss of tire inflation pressure, 0 psi/0 kPa, or obvious tire damage, you can determine the distance you may continue driving based on the following values:

- ▷ With a light load:
  - 1 to 2 persons without luggage:  
approx. 150 miles/250 km
- ▷ With a medium load:
  - 2 persons, luggage compartment full;  
or 5 persons without luggage:  
approx. 100 miles/150 km
- ▷ With a full load:
  - 5 persons, luggage compartment full:  
approx. 30 miles/50 km.

 Drive cautiously. Do not exceed a speed of 50 mph / 80 km/h. Be aware that vehicle handling will be altered when there is a loss in inflation pressure. Anticipate, e.g., reduced tracking during braking, longer braking distances and changed steering characteristics.

For safety reasons, BMW recommends not having damaged Run Flat tires repaired. In this case, consult your BMW center. ◀

## Battery

### Maintenance

The battery is maintenance-free, that is, the original electrolyte will normally last for the service life of the battery under moderate climatic conditions.

 Please consult your BMW center whenever you have any questions concerning the battery. ◀

### Charging the battery

When charging the battery in the vehicle, leave the engine off at all times. Connect the charge cables to the terminals in the engine compartment. For terminal locations, refer to Jump-starting on page 153.

### Disposal

 Return used batteries to a recycling point or your BMW center. Maintain the battery in an upright position for transport and storage. Secure the battery against tilting during transport. ◀

## Fuses

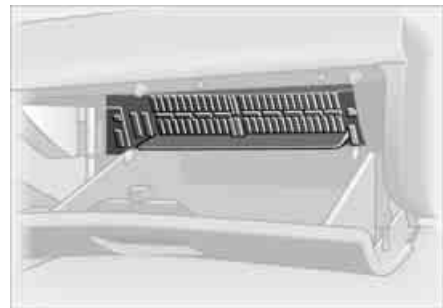

You will find the fuses and information on their respective allocation in the glove compartment behind a panel with two snap clips.

 Do not attempt to repair a blown fuse or replace it with a fuse having a different color or amperage rating. To do this could cause a fire in the vehicle resulting from a circuit overload. ◀

The BMW Group's Mobile Service offers you 24-hour assistance in the event of a breakdown, even on weekends and holidays.

The telephone numbers of the Mobile Service control center in your country are listed in the BMW Dealer Directory.

If your vehicle has the necessary equipment, you can contact the Mobile Service or issue an emergency call using buttons in the interior rearview mirror.

When an emergency call is initiated, a telephone connection is established with the general emergency call center.

In vehicles with activated BMW Assist function, a telephone connection is set up to the BMW Assist emergency call center. If the current location of your vehicle can be determined, this location is transmitted to the BMW Assist emergency call center.

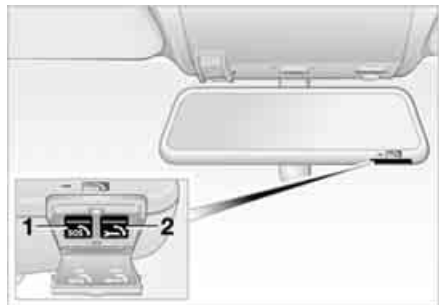

Fold down the cover.

- 1 Emergency call
- 2 Mobile Service

Requirements for initiating an emergency call or contacting Mobile Service:

- ▷ The car phone is registered with a mobile network
- ▷ The emergency call system is operational.

### Initiating an emergency call\*

Press button 1 for at least 2 seconds.

The indicator lamp above the buttons lights up. As soon as a telephone connection has been set up to the main emergency call center, the indicator lamp flashes.

If the indicator lamp is flashing but you cannot hear the emergency call center, you may still be heard by the emergency call center.

 For technical reasons, the emergency call function cannot be guaranteed in certain unfavorable conditions. ◀

If certain requirements are met, an emergency call is automatically initiated after a serious accident. The automatic emergency call will not be hindered by pressing the button.

### Mobile Service\*

To establish contact with the BMW Group's Mobile Service:

Press button 2 for at least 2 seconds.

The indicator lamp above the buttons lights up. As soon as a telephone connection has been set up with the Mobile Service, the indicator lamp flashes.

Depending on the country you are in, your vehicle's current location will also be transmitted if your vehicle is equipped with an activated BMW Assist function.



## Jump-starting

When your battery is discharged you can use two jumper cables to start your vehicle with power from the battery in a second vehicle. You can also use the same method to help start another vehicle. Only use jumper cables with fully insulated handles on the terminal clamps.

 Do not touch high-voltage wiring and cables on a running engine. Contact with components carrying high voltage can be harmful or fatal. Carefully observe the following instructions to avoid personal injury and/or damage to one or both vehicles. ◀

### Preparations

1. Check whether the battery of the support vehicle has 12 volts and approximately the same capacity – measured in Ah. This information is provided on the battery
2. Stop the engine of the support vehicle
3. Switch off all electrical components in both vehicles.

 Make absolutely certain that there is no contact between the bodywork of the two vehicles. Otherwise there is a short circuit hazard. ◀

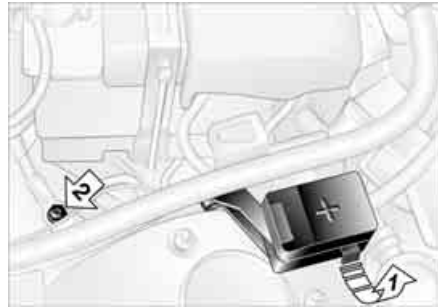

### Connecting the jumper cables

 Always adhere to this sequence when connecting jumper cables; failure to observe this procedure can lead to sparking and pose an injury hazard. ◀

The auxiliary jump-starting terminal located in your BMW's engine compartment acts as the positive battery terminal. Refer to the engine compartment overview on page 130. The cover of this auxiliary terminal is marked with a +.

1. Open the cover of the BMW auxiliary jump-starting terminal. Do so by pulling the tab – see arrow 1

2. Connect one terminal clamp of the plus/+ jumper cable to the positive terminal of the battery or to an auxiliary jump-starting terminal of the support vehicle
3. Connect the second terminal clamp of the plus/+ jumper cable to the positive terminal of the battery or to an auxiliary jump-starting terminal of the vehicle to be started
4. Your BMW is equipped with a special nut – see arrow 2 – to serve as the ground or negative terminal. Attach a terminal clamp of the minus/- jumper cable to the negative terminal of the support vehicle's battery or to a suitable ground on its engine or bodywork
5. Attach the second terminal clamp of the minus/- jumper cable to the negative terminal of the battery or to a suitable ground on the engine or bodywork of the vehicle to be started.

### Starting the engine

1. Start the engine of the support vehicle and let it run for several minutes at a slightly elevated engine idle speed

2. Start the engine of the other vehicle as usual.

If the first start attempt is not successful, wait a few minutes before another attempt in order to allow the discharged battery to recharge

3. Allow the engines to run for several minutes
4. Disconnect the jumper cables in reverse sequence.

Depending on the cause of the fault, have the battery checked and recharged by your BMW center.

 Do not use spray starter fluids to start the engine. ◀

## Towing the vehicle



Always observe all applicable towing laws and regulations. ◀

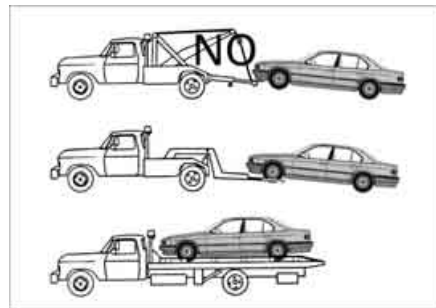

### Towing with a commercial tow truck

- ▷ Use wheel lift or flat bed carrier
- ▷ Do not tow with sling-type equipment.



Never allow passengers to ride in a towed vehicle for any reason. Never attach tie-down hooks, chains, straps, or tow hooks to tie rods, control arms, or any other part of the vehicle suspension, as severe damage to these components will occur, possibly leading to accidents. ◀

## Towing the vehicle

### Towing the vehicle with the front axle raised

Vehicles with automatic transmission:

1. Maximum towing speed: maximum 45 mph / 70 km/h
2. Maximum towing distance: maximum 90 miles/150 km.

Vehicles with sequential manual gear-box SMG:

While the ignition is on move the selector lever to position N, then turn off the ignition.

### 325xi, 330xi: towing the vehicle with the front or rear axle raised

1. Place the transmission in Neutral
2. Switch off the engine
3. Maximum towing speed: 30 mph / 50 km/h
4. Maximum towing distance: 90 miles/150 km.

 Remove the rear driveshaft for longer towing distances with the front axle lifted; remove the front driveshaft for towing over longer distances with the rear axle lifted. Failure to comply with this will result in damage to the transfer box. ◀

### Towing eyelet

The screw-in towing eyelet is stored in the onboard tool kit; be sure that it remains in the vehicle at all times. It can be attached at the front or rear of the vehicle. The towing eyelet should not be used to pull a vehicle out of deep snow, mud, sand, etc.

Always observe all applicable towing laws and regulations.



### Access to tow sockets

Front:

Press out the cover panel with a screwdriver inserted in the recess at the top.



Rear:

Press out the cover panel with a screwdriver inserted in the recess at the top.

 Use only the towing eyelet supplied with the vehicle and screw it in firmly until it stops. Use the towing eyelet for towing on paved roads only. If you do not follow these instructions, the towing eyelet could be torn out and vehicle damage could occur. Never attach tie-down hooks, chains, straps, or tow hooks to tie rods, control arms, or any other part of the vehicle suspension, as severe damage to these components will occur, possibly leading to accidents. ◀

 Avoid staggered towing and be careful that the towing strap is taut before starting to drive the vehicle doing the towing. ◀

Use only a nylon towing strap to tow the vehicle, since the inherent resilience of this material helps protect both vehicles from sudden jerking movements.

 The towed vehicle should always be the lighter of the two vehicles. If this is not the case, it will not be possible to control vehicle handling. ◀

### **Tow-starting**

For instructions on jump-starting, refer to page [153](#).

Never attempt to use your vehicle to push another vehicle, since damage to the energy-absorbing bumpers could result.



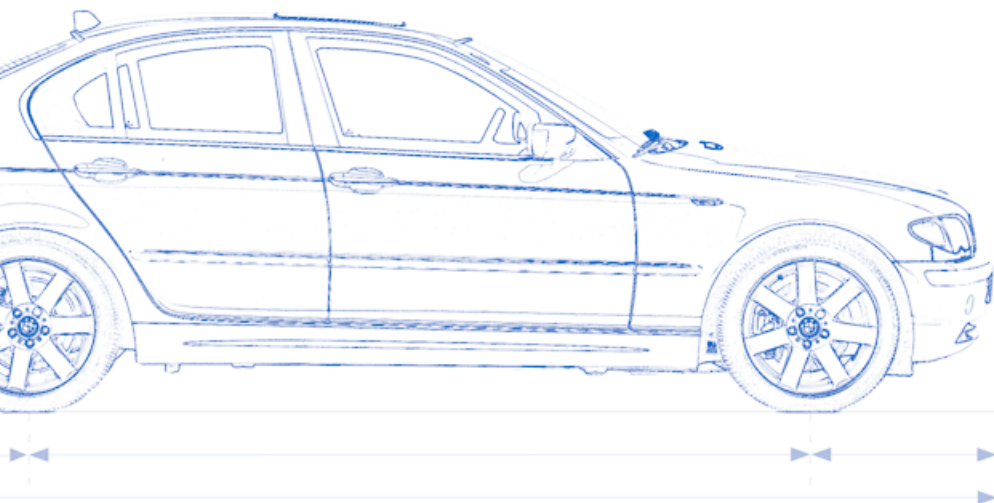

## Overview

Controls and features

Operation, maintenance

Owner service procedures

Technical data

Index

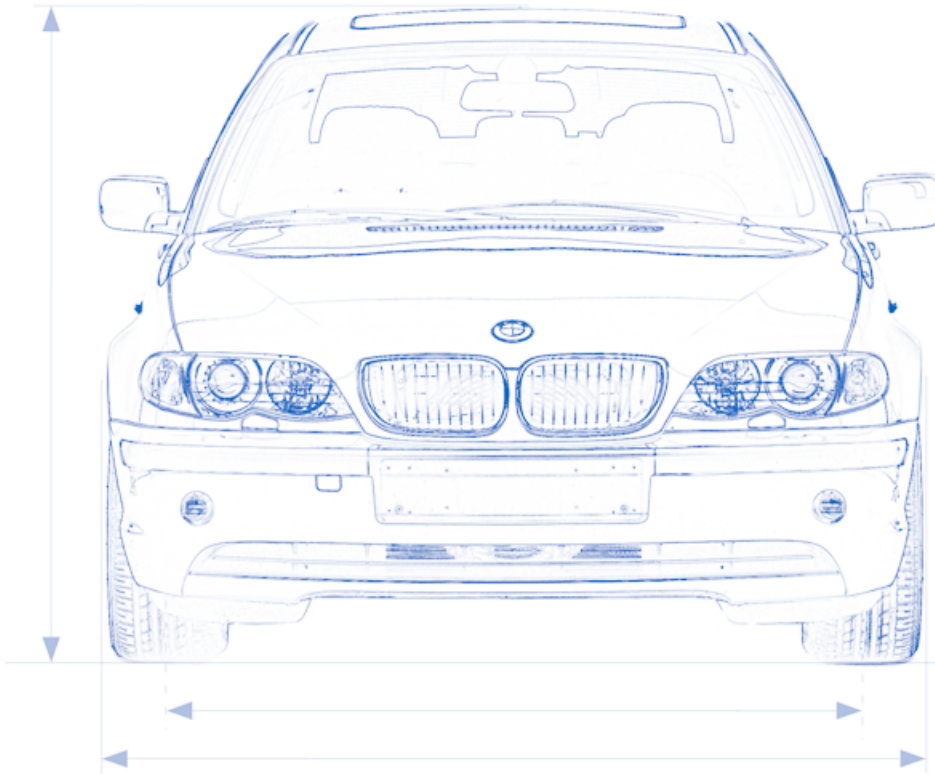

160 **Engine data**

		320i	325i, 325xi	330i, 330xi
Displacement	cu in/cm <sup>3</sup>	132.5/2,171	152.2/2,494	181.8/2,979
Number of cylinders		6	6	6
Maximum power output at engine speed	hp rpm	168 6,100	184 6,000	225 5,900
Max. torque at engine speed	lb ft/Nm rpm	155/210 3,500	175/237 3,500	214/290 3,500
Compression ratio	$\epsilon$	10.8	10.5	10.2
Stroke	in/mm	2.83/72	2.95/75	3.53/89.6
Bore	in/mm	3.15/80	3.31/84	3.31/84
Fuel mixture preparation			Digital electronic engine-management system (DME)	

325xi, 330xi: power can be tested only on a suitable dynamometer.



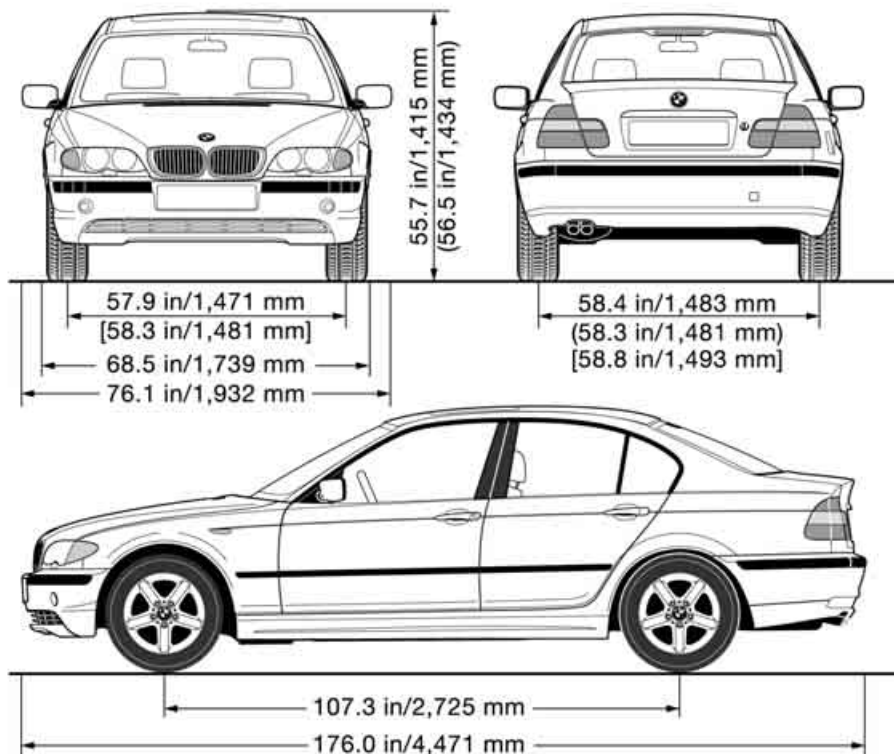

Dimensions in ( ) apply to 325xi/330xi.

Dimensions in [ ] apply to 320i.

Minimum turning circle dia.: 34.4 feet/10.5 m (35.8 feet/10.9 m).

162 **Weights**

		320i	325i	325xi	330i	330xi
Curb weight						
with manual transmission/SMG	lbs/kg	3,142/1,425	3,219/1,460	3,461/1,570	3,285/1,490	3,483/1,580
with automatic transmission	lbs/kg	3,219/1,460	3,307/1,500	3,527/1,600	3,362/1,525	3,538/1,605
Approved gross vehicle weight						
with manual transmission/SMG	lbs/kg	4,200/1,905	4,277/1,940	4,520/2,050	4,343/1,970	4,541/2,060
with automatic transmission	lbs/kg	4,277/1,940	4,365/1,980	4,586/2,080	4,420/2,005	4,597/2,085
Approved front axle load	lbs/kg	1,973/895	1,984/900	2,183/990	2,006/910	2,161/980
Approved rear axle load	lbs/kg	2,359/1,070	2,425/1,100	2,469/1,120	2,469/1,120	2,491/1,130
Approved roof load capacity	lbs/kg	165/75	165/75	165/75	165/75	165/75
Luggage compartment capacity	cu ft/l	15.5/440	15.5/440	15.5/440	15.5/440	15.5/440

Approved axle loads and approved gross vehicle weight must never be exceeded.

			Notes
Fuel tank	gal./liters	approx. 16.6/63	Fuel specification, refer to page <a href="#">25</a>
Reserve	gal./liters	approx. 2.1/8	
Windshield/ Headlamp washer reservoir	quarts/liters	approx. 5.6/5.3	Specifications, refer to page <a href="#">132</a>
Engine oil and filter change	quarts/liters	320i, 325i, 330i: approx. 6.9/6.5 325xi, 330xi: approx. 6.6/6.2	BMW High Performance Synthetic Oil Specifications, refer to page <a href="#">132</a>
Manual and automatic transmission, transfer box and differential		–	Lifetime lubricant, no oil change required

A B C  
P Q R



Overview

Controls and features

Operation, maintenance

Owner service procedures

Technical data

Index

Overview

Controls

Maintenance

Repairs

Data

Index

# Everything from A to Z

## A

ABS Antilock Brake System [121](#)  
indicator lamp [18](#)  
Acceleration assistant [72](#)  
Accessories, refer to For your own safety [5](#)  
Accident, refer to Emergency call [152](#)  
Activated-charcoal filter [106](#)  
ADB-X Automatic Differential Brake, all-wheel [89](#)  
Adding brake fluid [134](#)  
Additional sources of information [4](#)  
Air conditioning [98](#)  
Air conditioning mode [100](#)  
automatic climate control [104](#)  
Air distribution  
air conditioning [100](#)  
automatic climate control [104](#)  
Air distribution, individual [104](#)  
Air outlets, refer to Ventilation [98](#), [102](#)  
Air pressure, refer to Tire inflation pressure [25](#), [124](#)  
Air recirculation, refer to Recirculated-air mode [100](#), [105](#)

Air supply  
air conditioning [100](#)  
automatic climate control [104](#)  
Air, drying, refer to Air conditioning mode [100](#), [104](#)  
Airbags [57](#)  
indicator lamp [18](#), [59](#)  
sitting safely [47](#)  
Airing out, refer to Ventilation [98](#), [102](#)  
Alarm system [41](#)  
avoiding unintentional alarms [42](#)  
All-season tires, refer to Winter tires [127](#)  
Antifreeze [134](#)  
coolant [134](#)  
washer fluid [132](#)  
Antilock Brake System (ABS) [121](#)  
indicator lamp [18](#)  
Anti-theft system [32](#)  
Anti-theft warning system, refer to Alarm system [41](#)  
Approved axle loads, refer to Weights [162](#)  
Approved gross weight, refer to Weights [162](#)  
Armrest  
front [108](#)  
rear [109](#)

Artificial leather, refer to the Caring for your vehicle brochure  
Ashtray  
front [110](#)  
rear [111](#)  
Assistant systems, refer to Dynamic Stability Control (DSC) [87](#)  
AUC Automatic recirculated-air control [105](#)  
AUTO program, refer to Automatic air distribution [104](#)  
Automatic  
air distribution [104](#)  
air supply [104](#)  
cruise control [78](#)  
headlamp control [94](#)  
Automatic car wash, refer to the Caring for your vehicle brochure  
Automatic climate control [102](#)  
Automatic curb monitor [54](#)  
Automatic Differential Brake, all-wheel ADB-X [89](#)  
Automatic dimming, interior rearview mirror [56](#)  
Automatic recirculated-air control (AUC) [105](#)

Automatic transmission with Steptronic [73](#)  
indicator lamp [19](#), [75](#)  
interlock [65](#)  
selector lever lock [73](#)  
shiftlock [73](#)  
Automatic windshield washer, refer to Rain sensor [77](#)  
Average fuel consumption [85](#)  
Average speed [85](#)  
Avoiding unintentional alarms [42](#)  
Axle loads, refer to Weights [162](#)

## B

Backrest, adjusting [49](#)  
Backrest, refer to Seat adjustment [48](#), [50](#)  
Backup lamps [68](#)  
bulb replacement [145](#)  
Bandages, refer to First-aid kit [23](#)  
Battery [151](#)  
charge [151](#)  
disposal [151](#)  
indicator lamp [18](#)  
jump-starting [153](#)  
remote control [32](#), [33](#)  
Battery charge current [18](#)

- Belts, refer to Safety belts [51](#)
  - Beverage holders [108](#), [109](#)
  - Blower
    - air conditioning [100](#)
    - automatic climate control [104](#)
  - BMW High Performance Synthetic Oils [133](#)
  - BMW Maintenance System [136](#)
  - BMW sports seat [49](#)
  - Bore, refer to Engine data [160](#)
  - Bottle holders, see Beverage holders [108](#), [109](#)
  - Brake fluid [134](#)
    - indicator lamp [18](#), [134](#)
    - level [134](#)
  - Brake force display [93](#)
  - Brake hydraulic system [122](#)
  - Brake lamps
    - bulb replacement [145](#)
    - indicator lamp, defective lamp [82](#)
  - Brake lights
    - brake force display [93](#)
  - Brake pads
    - brake fluid level [18](#), [122](#), [134](#)
    - breaking in [120](#)
    - disc brakes [122](#)
  - Brake rotors
    - brake system [122](#)
    - breaking in [120](#)
  - Brake system
    - brake pads, indicator lamp [19](#)
  - Brake wear warning indicator lamp [19](#)
  - Brakes
    - ABS [121](#)
    - brake fluid [134](#)
    - breaking in [120](#)
    - indicator/warning lamp [18](#), [19](#)
    - parking brake [67](#)
  - Break-in procedures [120](#)
  - Bulb replacement, refer to Lamps and bulbs [143](#)
  - Bulb, replacing [143](#)
  - Buttons in steering wheel [22](#)
- C**
- California Proposition 65 warning [138](#)
  - Can holders, see Beverage holders [108](#), [109](#)
  - Capacities [163](#)
  - Car battery [151](#)
  - Car care, refer to the Caring for your vehicle brochure
  - Car keys, refer to Keys [32](#)
  - Car radio, refer to Owner's Manual for Radio/Onboard Computer
  - Car telephone
    - preparation [110](#)
  - Car telephone, refer to the separate Owner's Manual
  - Car vacuum cleaner, connecting [110](#)
  - Car wash, refer to the Caring for your vehicle brochure
  - Carpet care, refer to the Caring for your vehicle brochure
  - Cassette operation, refer to the Owner's Manual for Radio/Onboard Computer
  - CBC Cornering Brake Control [121](#)
    - warning lamp [18](#)
  - CD changer, refer to the Owner's Manual for Radio/Onboard Computer
  - CD operation, refer to the Owner's Manual for Radio/Onboard Computer
  - Cellular phone [110](#)
  - Center high-mount brake lamp
    - bulb replacement [146](#)
  - Central locking system [32](#)
    - button [37](#)
    - passenger compartment [37](#)
  - Changing a wheel [147](#)
  - Charge indicator lamp [18](#)
  - Check Control [82](#)
  - Check Gas Cap indicator lamp [19](#)
  - Child safety locks [63](#)
  - Child seats [60](#)
  - Child-restraint systems [60](#)
  - Chock [148](#)
  - Cigarette lighter [110](#)
  - Cigarette lighter socket [110](#)
  - Cleaning chrome parts, refer to the Caring for your vehicle brochure
  - Cleaning light alloy wheels, refer to the Caring for your vehicle brochure
  - Cleaning the vehicle, refer to the Caring for your vehicle brochure
  - Cleaning windshield [78](#)
  - Clock [83](#)
    - 12-/24-hour mode [83](#)
    - setting, refer also to the Owner's Manual for Radio/Onboard Computer

# Everything from A to Z

- Closing
  - from inside [37](#)
  - from outside [33](#)
- Clothes hooks [121](#)
- Clutch
  - breaking in [120](#)
- Cockpit [14](#)
- Code, refer to the Owner's Manual for Radio/Onboard Computer
- Coin box [108](#)
- Cold start, refer to Starting the engine [65](#)
- Compact disc operation, refer to the Owner's Manual for Radio/Onboard Computer
- Compartments [108](#)
- Compression ratio, refer to Engine data [160](#)
- Computer [84](#)
- Condensation, refer to Air conditioning mode [100, 104](#)
- Configuring settings, refer to Vehicle Memory, Key Memory [64](#)
- Connecting a vacuum cleaner, refer to Cigarette lighter [110](#)
- Consumption
  - display [80](#)
- Consumption, refer to Average fuel consumption [85](#)
- Control elements, refer to Cockpit [14](#)
- Convenience operation
  - from outside [36](#)
  - glass sunroof [34](#)
  - windows [34](#)
- Coolant [134](#)
  - indicator lamp [19, 81](#)
  - level [134](#)
  - temperature gauge [81](#)
- Coolant water, refer to Coolant [134](#)
- Cooling, refer to Temperature [100, 104](#)
- Copyright [4](#)
- Cornering Brake Control (CBC) [121](#)
  - warning lamp [18](#)
- Correct tires [127](#)
- Cruise control [78](#)
  - indicator lamp [20](#)
- Cup holders, see Beverage holders [108, 109](#)
- Curb weight, refer to Weights [162](#)
- Current consumption, refer to Energy control [80](#)
- Cylinders, refer to Engine data [160](#)
- D**
- Dashboard, refer to Cockpit [14](#)
- Data
  - capacities [163](#)
  - dimensions [161](#)
  - engine [160](#)
  - technical [160](#)
  - weights [162](#)
- Daytime driving lamps [94](#)
- DBC Dynamic Brake Control [19, 121](#)
- Deep water, refer to Water on roadways [121](#)
- Defrost position, refer to Defrosting windows [101, 104](#)
- Defrosting and demisting windows
  - air conditioning [101](#)
  - automatic climate control [104](#)
- Defrosting windows [101, 104](#)
- Defrosting windshield, refer to Defrosting windows [101, 104](#)
- Demisting windows
  - air conditioning [101](#)
  - automatic climate control [104](#)
- Determining the maximum load [115](#)
- Differential
  - breaking in [120](#)
- Digital clock [83](#)
- Dimensions [161](#)
- Dipstick, engine oil [132](#)
- Disc brakes [122](#)
- Displacement, refer to Engine data [160](#)
- Display lighting, refer to Instrument lighting [95](#)
- Displays, refer to Instrument cluster [16](#)
- Disposal
  - oil [133](#)
  - vehicle battery [151](#)
- Distance warning, refer to Park Distance Control (PDC) [86](#)
- Divided rear backrest [112](#)
- Door key [32](#)
- Door lock [36](#)
- Doors
  - emergency operation [36](#)
- Draft-free ventilation [101, 105](#)
- Driving light, refer to Parking lamps/Low beams [94](#)
- Driving notes [121](#)
- Dry air, refer to Air conditioning mode [100, 104](#)



DSC Dynamic Stability Control 87

indicator lamp 19, 87

DTC Dynamic Traction Control 87

indicator lamp 19, 87

Dynamic Brake Control (DBC) 19, 121

Dynamic Brake Control DBC indicator lamp 19

Dynamic Stability Control (DSC) 19, 87

Dynamic Traction Control (DTC) 87

indicator lamp 19, 87

## E

Electric glass sunroof 44

Electric power windows 43

Electrical accessories, failure 151

Electrical malfunction

automatic transmission with Steptronic 75

door lock 36

driver's door 36

fuel filler door 24

glass sunroof 46

luggage compartment lid 38

Electronic Stability Program ESP, refer to Dynamic Stability Control DSC 87

Emergency call 152

Emergency operation doors 36

driver's door 36

fuel filler door 24

glass sunroof 46

Emergency release luggage compartment lid 38, 40

Emissions, minimum, refer to Energy control 80

Energy control 80

Engine

breaking in 120

data 160

electronics 19

indicator lamp 19

speed 80, 160

starting 65

switching off 67

Engine compartment 130

Engine coolant 134

adding 134

Engine oil

adding 133

additives, refer to Adding engine oil 133

capacity 163

consumption 132

indicator/warning lamp 19

quality 133

types 133

viscosity 133

Engine oil level 19

check 132

indicator/warning lamp 18

Engine oil pressure

indicator/warning lamp 18

Engine output, refer to

Engine data 160

Engine speed 80, 160

Environmentally-friendly

driving, refer to Energy control 80

ESP Electronic Stability Program, refer to Dynamic Stability Control (DSC) 87

Exterior mirrors 55

Eyeglasses

compartment 109

Eyelet, towing 155

## F

False alarm, refer to Avoiding unintentional alarms 42

Fastening the safety belts 51

Fault displays 82

First aid, refer to First-aid kit 23

First-aid kit 23

Flashlight 108

Flashlight, refer to

Rechargeable flashlight 108

Flat tire 147

Flat Tire Monitor 92

space-saver spare tire 147

Flat Tire Monitor 92

indicator lamp 18, 19, 93

Flat tire, refer to Tire condition 124

Fluid reservoir for washer systems 132

Fog lamps 96

indicator lamp 20

Folding rear backrest 112

Follow me home lamps 94

Footbrake, refer to General driving notes 121

Front airbags 57

Front center armrest 108

Front fog lamps 96

indicator lamp 20

# Everything from A to Z

- Fuel
  - display [81](#)
  - quality [25](#)
  - volume [163](#)
- Fuel consumption
  - display [80](#), [85](#)
- Fuel display, refer to Fuel gauge [81](#)
- Fuel economy, refer to Energy control [80](#)
- Fuel filler door [24](#)
  - release following an electrical malfunction [24](#)
- Fuel level indicator, refer to Fuel gauge [81](#)
- Fuel mixture preparation [160](#)
- Fuel reserve indicator, refer to Fuel gauge [81](#)
- Fuel tank capacity [163](#)
- Fuses [151](#)
- G**
- Gasoline consumption, refer to Average fuel consumption [85](#)
- Gasoline, refer to Fuel specifications [25](#)
- Gear indicator [71](#), [75](#)
- Gear lever
  - automatic transmission with Steptronic [73](#)
  - sequential manual gearbox SMG [69](#)
- Gearbox
  - manual transmission [68](#)
- Gearshift lever
  - manual transmission [68](#)
- General driving notes [121](#)
- Glass sunroof
  - closing following an electrical malfunction [46](#)
  - convenience operation [34](#), [36](#)
  - remote control [33](#), [34](#)
- Glass sunroof, electric [44](#)
- Glove compartment [107](#)
- Grills, refer to Ventilation [98](#), [102](#)
- Gross weight, refer to Weights [162](#)
- H**
- Handbrake, refer to Parking brake [67](#)
- Hands-free system [110](#)
- Harman Kardon premium sound system [107](#)
- Hazard warning flashers [14](#)
- Hazard warning triangle [23](#)
- HDC Hill Descent Control [91](#)
- Head airbags [57](#)
- Head restraints [51](#)
- Headlamp cleaning system
  - cleaning headlamps [78](#)
  - washer fluid [132](#), [163](#)
- Headlamp control, automatic [94](#)
- Headlamp flasher [95](#)
- indicator lamp [21](#)
- Headlamps
  - bulb replacement [143](#)
  - care, refer to the Caring for your vehicle brochure
- Heated mirrors [55](#)
- Heated rear window
  - air conditioning [100](#)
  - automatic climate control [105](#)
- Heated seats [54](#)
- Heating
  - exterior mirrors [55](#)
  - rear window [100](#), [105](#)
  - seats [54](#)
- Heating and ventilation [98](#), [102](#)
- Heavy loads, refer to Cargo loading [115](#)
- Height adjustment
  - seats [48](#), [50](#)
  - steering wheel [55](#)
- Height, refer to Dimensions [161](#)
- High beams [76](#), [95](#)
  - bulb replacement [143](#)
  - headlamp flasher [95](#)
  - indicator lamp [21](#)
- Hill Descent Control (HDC) [91](#)
- Holder for
  - beverages [108](#), [109](#)
  - litter bag [109](#)
- Hood release [129](#)
- Horn [14](#)
- Hub cap [148](#)
- Hydraulic brake assistant, refer to DBC [121](#)
- Hydraulic system
  - brakes [122](#)
- Hydroplaning [121](#)
- I**
- Ice warning [84](#)
- Ignition [65](#)
- Ignition key [32](#)
  - positions [65](#)
- Ignition lock [65](#)
- Imprint [4](#)
- Indicator lamps [18](#)

## Indicator/warning lamp

- airbags 18
  - alarm system 42
  - brakes 18, 19
  - Check Gas Cap 19
  - coolant 19, 81
  - DSC 19
  - Flat Tire Monitor 18, 19, 93
  - fog lamps 20
  - Please fasten safety belts 18
  - reserve 81
  - Service Engine Soon 19
- ## Individual air distribution 104
- ## Individual settings, refer to
- Vehicle Memory, Key Memory 64
- ## Inflation pressure 124
- ## Inflation pressure monitoring, refer to Flat Tire Monitor 92
- ## Inflation pressure, tires 25
- ## INSPECTION 82
- ## Instrument cluster 16
- ## Instrument lighting 95
- ## Instrument panel, refer to
- Cockpit 14
- ## Interface socket for onboard diagnostics (OBD) 138
- ## Interior lamps 96
- remote control 34

- Interior motion sensor 41
  - switching off 42
- Interior rearview mirror 56
  - automatic dimming feature 56
- Interior temperature
  - adjusting 100, 104
- Interlock, refer to Steering wheel lock 65
- Intermittent
  - mode, wipers 77
- Interval
  - display, service 82

## J

- Jack 147
- Jacking points 148
- Jump-starting 153

## K

- Key Memory 64
- Keys 32
  - with remote control 32
- Kickdown 70, 74

## L

- Lamp defect 143
- Lamps and bulbs 143
- Lashing down loads, refer to
  - Cargo loading 114
- Lashing eyelets, refer to
  - Securing cargo 116

## Lashing fittings, refer to

- Securing cargo 116
- ## LATCH child-restraint mounting system 62
- ## Leather care, refer to the
- Caring for your vehicle brochure
- ## LEDs light-emitting diodes 96
- ## Length, refer to
- Dimensions 161
- ## License plate lamp - bulb replacement 147
- ## Light switch 94
- ## Light-emitting diodes - LEDs 96
- ## Lighter 110
- ## LIGHTS ON warning 94
- ## Lights, refer to Parking lamps/Low beams 94
- ## Litter bag holders 109
- ## Load, refer to Cargo loading 114
- ## Loading - vehicle 114
- ## Load-securing devices 116
- ## Lock buttons on doors, refer to Locking 37
- ## Lock, steering wheel 65
- ## Locking - from inside 37 - from outside 33, 36

## Locking and unlocking doors

- from inside 37
  - from outside 33, 36
- ## Low beams 94
- automatic 94
  - bulb replacement 143
  - indicator lamp, defective lamp 82
- ## Lug bolts 148
- key 148
  - torque 148
- ## Luggage compartment capacity 162
- emergency operation, refer to Manual operation 38
  - floor mat 41
  - floor panel 40
  - lid 38
  - lighting 38
  - opening from outside 38
  - opening, remote control 34
  - opening/closing, refer to Luggage compartment lid 38
  - remote control 34
  - volume 162

# Everything from A to Z

Luggage compartment lid [38](#)  
emergency operation [38](#)  
emergency release [40](#)  
indicator lamp [82](#)  
opening from inside the vehicle [38](#), [39](#)  
opening from outside [38](#)  
remote control [34](#)  
securing separately [38](#)  
unlocking manually [38](#)  
Luggage rack, refer to Roof-mounted luggage rack [117](#)  
Lumbar support [50](#)

## M

M+S tires, refer to Winter tires [127](#)  
Maintenance [82](#), [136](#)  
Maintenance system [136](#)  
Making telephone calls, refer to the telephone Owner's Manual  
Malfunction  
door lock [36](#)  
fuel filler door [24](#)  
Malfunction displays [82](#)

Manual operation  
door lock [36](#)  
driver's door [36](#)  
fuel filler door [24](#)  
glass sunroof [46](#)  
luggage compartment lid [38](#)  
Manual transmission [68](#)  
Master keys  
with remote control [32](#)  
MC operation, refer to the Owner's Manual for Radio/Onboard Computer  
MD operation, refer to the Owner's Manual for Radio/Onboard Computer  
Mechanical seats [48](#)  
Memory, refer to Seat and mirror memory [53](#)  
Memory, refer to Vehicle Memory, Key Memory [64](#)  
Microfilter  
air conditioning [101](#)  
automatic climate control [106](#)  
Microphone, refer to Cellular phone [110](#)  
Mini disc operation, refer to the Owner's Manual for Radio/Onboard Computer

Mirrors [55](#)  
automatic curb monitor [54](#)  
heated [55](#)  
memory, refer to Seat and mirror memory [53](#)  
Mobile Service [152](#)  
Modifications, technical, refer to For your own safety [5](#)  
Multifunction steering wheel [22](#)  
Multifunction switch  
turn signal indicator/headlamp flasher [76](#)  
washer/wiper system [77](#)

## N

Navigation system, refer to the Owner's Manual for Radio/Onboard Computer  
Neck restraints, refer to Head restraints [51](#)  
Nets [108](#)  
Nozzles, refer to Ventilation [98](#), [102](#)

## O

OBD interface socket [138](#)  
Odometer [80](#)

## Oil

additives, refer to Adding engine oil [133](#)  
capacity [163](#)  
dipstick [132](#)  
quality [133](#)  
viscosity [133](#)  
Oil change interval, refer to Service interval display [136](#)  
Oil change intervals, refer to the Service and Warranty Information Booklet for US models/Warranty and Service Guide Booklet for Canadian models  
Oil consumption [132](#)  
Oil dipstick [132](#)  
Oil filter change [163](#)  
Oil level  
checking [132](#)  
indicator lamp [18](#)  
Oil pressure  
indicator lamp [18](#)  
OIL SERVICE [82](#)  
Oil types [133](#)  
Old batteries, refer to Disposal [151](#)  
Onboard computer [84](#)  
Onboard computer, refer to the Owner's Manual for Onboard Computer

Onboard tool kit [142](#)  
Opening and closing  
  from inside [37](#)  
  from outside [33](#)  
  via door lock [36](#)  
  via remote control [33](#)  
Outlets, ventilation [98](#), [102](#)  
Outside temperature display [84](#)  
changing unit of measure [84](#)

## P

Paintwork care, refer to the Caring for your vehicle brochure  
Panel lighting [95](#)  
Panic mode – trigger alarm [34](#)  
Park Distance Control (PDC) [86](#)  
Parking aid, refer to Park Distance Control PDC [86](#)  
Parking brake [67](#)  
  indicator lamp [18](#)  
Parking lamps [94](#)  
  bulb replacement [144](#)  
Parking lamps/Low beams [94](#)  
Parts and accessories, refer to Your individual vehicle [5](#)

Passenger-side exterior mirror tilt function [54](#)  
PDC Park Distance Control [86](#)  
Pinch protection  
  glass sunroof [45](#)  
Plastic, refer to the Caring for your vehicle brochure  
Please fasten safety belts indicator lamp [18](#)  
Pollen, refer to Microfilter [101](#)  
Pollen, refer to Microfilter/Activated-charcoal filter [106](#)  
Power output, refer to Engine data [160](#)  
Power seat [50](#)  
Power windows  
  safety switch [44](#)  
Pressure monitoring, tires Flat Tire Monitor [92](#)  
Pressure, tires [25](#), [124](#)  
Protective function  
  electric power windows [43](#)  
Putting the vehicle into storage  
  refer to the Caring for your vehicle brochure

## R

Radio remote control key, refer to Master key with remote control [32](#)  
Radio, refer to the Owner's Manual for Radio  
Rain sensor [77](#)  
Raising the floor panel [40](#)  
Range [85](#)  
Reading lamps  
  front [96](#)  
  rear [96](#)  
Rear armrest, refer to Rear center armrest [109](#)  
Rear backrest, folding [112](#)  
Rear center 3-point safety belt [112](#)  
Rear center armrest [109](#)  
Rear lamps  
  bulb replacement [145](#)  
  indicator lamp, defective lamp [82](#)  
Rear window defroster  
  air conditioning [100](#)  
Rear window heating  
  automatic climate control [105](#)  
Rearview mirror [55](#)  
Receiving assistance [152](#)

Recirculated-air mode  
  air conditioning [100](#)  
  automatic climate control [105](#)  
Recirculating the air, refer to Recirculated-air mode [100](#), [105](#)  
Reclining seat, refer to Seat adjustment [48](#), [50](#)  
Refueling [24](#)  
  fuel filler door [24](#)  
Releasing  
  hood [129](#)  
Remaining distance to service [82](#)  
Remaining distance, refer to Range [85](#)  
Remote control [33](#)  
  luggage compartment lid [34](#)  
  malfunction [34](#)  
Replacement key [33](#)  
Replacing lamps, refer to Lamps and bulbs [143](#)  
Replacing tires [125](#)  
Reporting safety defects [7](#)  
Restraint systems  
  for children [60](#)  
Restraint systems, refer to Safety belts [51](#)

# Everything from A to Z

Reverse  
  automatic transmission  
  with Steptronic 73  
  SMG gearbox 70

Reverse gear  
  manual transmission 68

Roller sun blind 106

Roof load capacity 162

Roof-mounted luggage  
  rack 117

Run Flat tires 126, 150

## S

Safe seating position 47

Safety belt height adjustment 52

Safety belts 51  
  sitting safely 47  
  warning lamp 18

Safety feature  
  glass sunroof 45

Safety precautions 5

Safety switch for rear windows 44

Safety systems, refer to  
  Antilock Brake System 121  
  Dynamic Stability Control (DSC) 87

Screwdriver, refer to  
  Onboard tool kit 142

Seat adjustment 48  
  BMW sports seat 49  
  mechanical 48  
  power 50

Seat belt tensioner, refer to  
  Safety belts 51

Seat heating 54

Seat memory, refer to Seat  
  and mirror memory 53

Seat positions, storing 53

Seats 48

Securing cargo 116

Securing the vehicle  
  from inside 37  
  from outside 33, 36

Selector lever  
  automatic transmission 73  
  sequential manual gearbox SMG 69

Selector lever lock, refer to  
  Shiftlock 69, 73

Selector lever positions  
  automatic transmission 73  
  sequential manual gearbox SMG 69

Sequential manual gearbox  
  SMG 69  
  indicator lamp 19

Service and Warranty Information Booklet 136

SERVICE ENGINE SOON  
  warning lamp 19

Service interval display  
  82, 136

Shift paddles 70

Shifting gears  
  automatic transmission  
  with Steptronic 73  
  sequential manual gearbox SMG 70

Shiftlock 69

Shiftlock, refer to Range  
  selection 73

Side airbags 57

Side turn signal indicators  
  bulb replacement 145

Sitting safely  
  with airbags 47  
  with safety belts 47

Size 161

Ski bag 113

Sliding/tilt sunroof, refer to  
  Electric glass sunroof 44

SMG sequential manual  
  gearbox 69  
  indicator lamp 19

Smokers' package, refer to  
  Ashtray 110

Snow chains 128

Socket, refer to Cigarette  
  lighter socket 110

SOS, refer to Emergency  
  call 152

Space-saver spare tire  
  changing a wheel 147

Spare key 32

Spare tire 147

Spare wheel 150

Speed gauge, refer to  
  Speedometer 16

Speedometer 16

SPORT button 72

Sport program  
  automatic transmission  
  with Steptronic 74

Sports seat 49

Stability control, refer to  
  Dynamic Stability Control (DSC) 87

Standing lamps 95

Starting difficulties  
  jump-starting 153  
  temperature 65

Starting help DSC 87

Starting the engine 65

Starting, refer to Starting the  
  engine 65

Status of the Owner's Manual 5

Steering wheel lock 65

Steering wheel, adjusting 55

Steptronic, refer to Manual  
  operation 74

Storage compartments 108

Storage nets 108

- Storing seat positions, refer to Seat and mirror memory [53](#)
- Storing tires [127](#)
- Stroke, refer to Engine data [160](#)
- Sun blind, refer to Roller sun blind [106](#)
- Surface ice, refer to Ice warning [84](#)
- Switches, refer to Cockpit [14](#)
- Switching off engine [67](#)  
vehicle [67](#)
- Symbols [4](#)
- Synthetic oils [133](#)
  
- T**
- Tachometer [80](#)
- Tail lamps bulb replacement [145](#)
- Tail lamps, refer to Rear lamps [145](#)
- Tank capacity, refer to Fuel tank capacity [163](#)
- Tank indicator, refer to Fuel gauge [81](#)
- Technical data [160](#)
- Technical modifications, refer to For your own safety [5](#)
- Telephone hookup [110](#)
- Telephone, refer to the separate Owner's Manual
- Television, refer to the Owner's Manual for Onboard Computer
- Temperature air conditioning [100](#)  
automatic climate control [104](#)
- Temperature adjustment [100](#), [104](#)
- Temperature display engine coolant [81](#)  
ice warning [84](#)  
outside temperature [84](#)  
setting units [84](#)
- Temperature layering [101](#), [105](#)
- Tempomat, refer to Cruise control [78](#)
- Third support area, adjusting [49](#)
- Third brake lamp, refer to Center high-mount brake lamp [146](#)
- Three-point safety belt [51](#)
- Through-loading system [112](#)
- Tilt alarm deactivate [42](#)
- Tilt alarm sensor [34](#)  
remote control [34](#)
- Tilting passenger-side exterior mirror [54](#)
- Time [83](#)
- Tire pressure monitoring, refer to Flat Tire Monitor [92](#)
- Tire replacement [125](#), [147](#)
- Tires age [126](#)  
breaking in [120](#)  
changing [147](#)  
condition [128](#)  
damage [124](#)  
flat [147](#)  
inflation pressure [25](#), [124](#)  
replacing [125](#)  
size, refer to Wheel and tire combinations [127](#)  
storing [127](#)  
tread [124](#)  
treadwear indicator, refer to Tire tread – tire damage [124](#)  
winter tires [127](#)
- Tools, refer to Onboard tool kit [142](#)
- Torque engine [160](#)  
lug bolts [148](#)
- Tow sockets for towing eyelet [155](#)
- Towing eyelet [155](#)
- Towing the vehicle [154](#)
- Track width, refer to Dimensions [161](#)
- Transmission automatic transmission with Steptronic [73](#)  
sequential manual gearbox SMG [69](#)
- Transmission lock, refer to P Park [73](#)
- Transmission malfunction automatic transmission with Steptronic [75](#)  
sequential manual gearbox SMG [71](#)
- Transport securing devices, refer to Securing cargo [116](#)
- Transporting children safely [60](#)
- Trap protection electric power windows [43](#)
- Tread depth, refer to Tire tread [124](#)

# Everything from A to Z

Treadwear indicator in the tires, refer to Tire tread – tire damage [124](#)

Treadwear, tires [124](#)

Trigger alarm – Panic mode [34](#)

Trip distance recorder, refer to Trip odometer [80](#)

Trip meter, refer to Trip odometer [80](#)

Trip odometer [80](#)

Trunk lid, refer to Luggage compartment lid [38](#)

Trunk lighting, refer to Luggage compartment lighting [38](#)

Turn signal indicator [76](#)  
bulb replacement [144](#)  
indicator lamp [20](#)

Turn signal indicator, side bulb replacement [145](#)

Turning circle, refer to Dimensions [161](#)

TV function, refer to the Owner's Manual for Onboard Computer

## U

Underbody protection, refer to the Caring for your vehicle brochure

Uniform Tire Quality Grading [126](#)

## Units

average fuel consumption [85](#)  
temperature [84](#)

## Unlocking

from inside [37](#)  
from outside [33, 36](#)

## V

### Valve

screw caps [148](#)

### Vehicle

battery [151](#)  
break-in procedures [120](#)  
care, refer to the Caring for your vehicle brochure  
dimensions [161](#)  
loading [114](#)  
starting [65](#)  
switching off [67](#)  
washing, refer to the Caring for your vehicle brochure [77](#)  
weight [162](#)

Vehicle Memory [64](#)

### Vehicle storage

refer to the Caring for your vehicle brochure

Vehicle weight [162](#)

Ventilation [98, 102](#)

draft-free [101, 105](#)

Viscosity [133](#)

Voice Input System [22](#)

Voice recognition, refer to separate Owner's Manual

## Volume

luggage compartment [162](#)

## W

Warning and indicator lamps [18](#)

Warning lamp 'Please fasten safety belts' [18](#)

Warning messages [82](#)

Warranty and Service Guide Booklet [136](#)

Warranty, refer also to separate booklet [7](#)

Washer fluid  
adding [132, 163](#)

Washer fluid reservoir [132](#)  
volume [132](#)

Washer jets, refer to Windshield washer jets [78](#)

Washer/wiper system [77, 78](#)  
washer fluid [132](#)

Waste tray, refer to Ashtray [110](#)

Water on roadways, deep water [121](#)

Weights [162](#)

Wheel and tire combinations [127](#)

Wheelbase, refer to Dimensions [161](#)

Wheels and tires [127](#)

Wheel slip control DSC [87](#)

## Width, refer to

Dimensions [161](#)

Window condensation removing [101, 104](#)

## Windows

convenience operation [34, 36](#)

power [43](#)

remote control [33, 34](#)

Windshield washer nozzles [78](#)

Windshield washer reservoir volume, see Capacities [163](#)

Windshield washer reservoir, filling [163](#)

Windshield wiper blades replacing [142](#)

Windshield wipers, refer to Washer/wiper system [77](#)

Winter tires [127](#)  
condition [128](#)  
storing [127](#)

Work in the engine compartment [129](#)



Wrench, refer to Onboard  
tool kit [142](#)

## **X**

Xenon lamps  
bulb replacement [143](#)







# Refueling



To ensure that you always have convenient access to all essential information when you stop for fuel, we recommend that you fill out the adjoining chart by entering the data that apply to your vehicle. Consult the index for individual specifications.

## Fuel

Designation	
-------------	--

Please enter your preferred fuel here.

## Engine oil

Quality	
---------	--

The oil volume between the two marks on the dipstick corresponds to approx. 1.1 US quarts/1 liter.

## Tire inflation pressure

	Summer tires		Winter tires	
	Front	Rear	Front	Rear
Up to 4 persons				
5 persons or 4 plus luggage				

More about BMW

[bmwusa.com](http://bmwusa.com)



The Ultimate  
Driving Machine